

ISOMETRIC VIEW
SCALE 1:1

EXPLODED VIEW

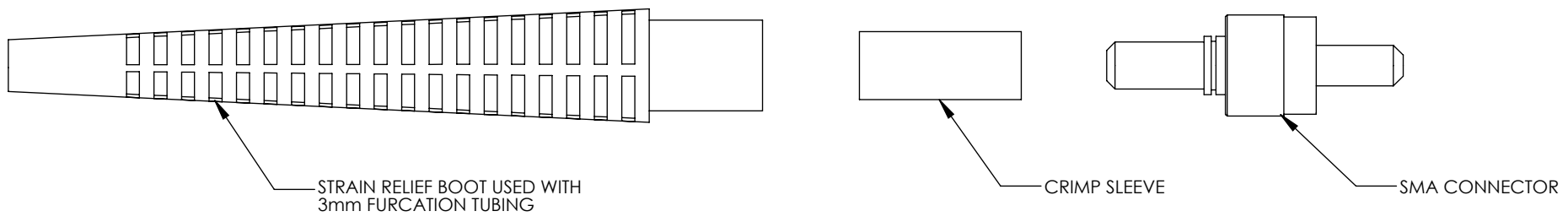

ASSEMBLED VIEW

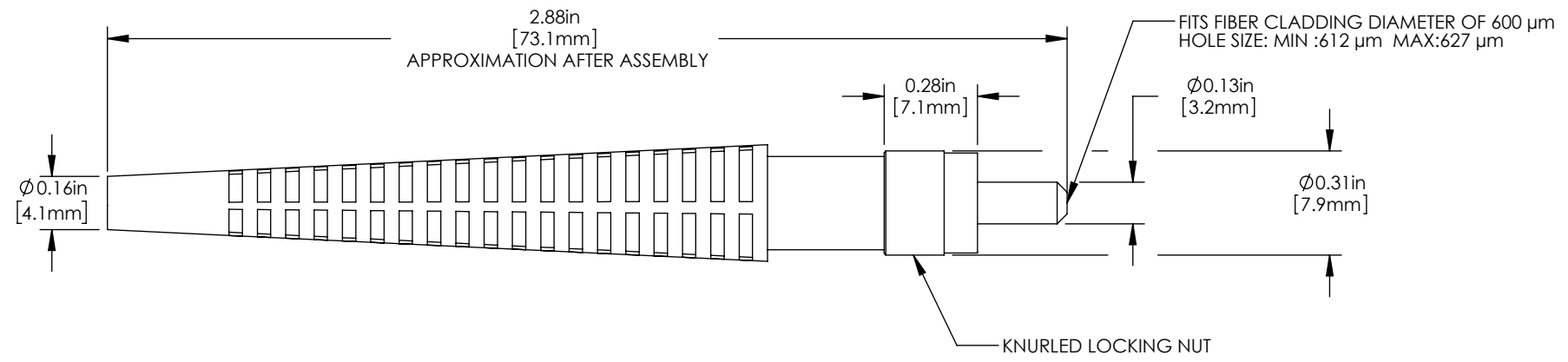

FOR INFORMATION ONLY
NOT FOR MANUFACTURING PURPOSES

DRAWING PROJECTION			THORLABS www.thorlabs.com	
NAME	DATE			
DRAWN	KH	27/JUL/11	610µm SMA CONNECTOR	
APPROVAL	KB	27/JUL/11	MATERIAL	REV A
COPYRIGHT © 2010 BY THORLABS			N/A	
VALUES IN PARENTHESIS ARE CALCULATED AND MAY CONTAIN ROUND OFF ERRORS		ITEM #	APPROX WEIGHT	
		10610A	0.01kg	