



LASER OPTICS CATALOG



People and Products You Can Rely On

TABLE OF CONTENTS

About OPHIR OPTICS		Ophir - A Newport Company	3
		Optics for High Power Industrial Lasers	4
		One-Stop-Shop Capabilities	5
1-Micron Optics	Tutorial	Introduction	8-9
	FiberLens™	Ophir 1-Micron Optics	10
		Specifications	10
		Common Fiber Lenses and Protective Windows	11
Cutting Head Optics	Tutorial	Lens Types, Focal Length and Mounting-Distance	14
		Spherical Aberration	14
		Diffraction	15-16
		Absorption and Thermal Lensing	16-17
		Benefits of Low Absorption Lenses	17
	CO ₂ Laser Lenses	Mechanical and Coating Specifications	18-19
		Duralens™	20
		Black Magic™	21
		Clear Magic™	22
		Common CO ₂ lenses	23-24
		EZ Mount™	25-26
Beam Delivery Optics	Tutorial		28
	Specifications	Mechanical and Coating Specifications	29
	Folding Mirrors (ZPS)	Coating Types for Beam Delivery Mirrors	30
		Common Folding Mirrors	31-32
	Phase Retarders (90PS)	Coating Types	33
		Common Mirrors	34
	ATFR High Reflection Mirrors	Common ATFR High Reflection Mirrors	35
	Telescopic Mirrors	Telescopic Mirrors Tutorial	36
		Telescopic Mirrors Specifications	37
		Common Telescopic Mirrors	38-39

TABLE OF CONTENTS

Cavity (Resonator) Optics	Tutorial	Total Reflectors	42	
		Polarization Locking Mirrors (PLM)	42	
	Total Reflectors Specifications	High Reflection PLM Mirrors	42	
		Mechanical and Coating Specifications	43	
	End Mirrors and Output Couplers	Common Total Reflectors and PLM Mirrors	44	
		End Mirrors Specifications	46	
		Common End Mirrors	47	
		Output Couplers Specifications	48	
	Optical Component Fabrication		Common Output Couplers	49-50
			High Precision CNC Polishing	52
Diamond Turning			53	
Thin Film Optical Coatings			54	
Quality Assurance			55	
Optical Lens Assembly			56	
Research and Development			57	
Maintenance	Cleaning and Handling	CO ₂ Optics Cleaning Instructions	60-61	
		Cleaning Kit	62	
		EZ Clean™ and EZ Clean™ Plus wipes	63	
		EZ Cleaning Instructions	64-65	
		EZ Test™ Stress Check Instructions	66-67	



OPHIR OPTICS

About Ophir Optics

Ophir - a Newport Company

Newport Corporation (NASDAQ: NEWP) is a leading global supplier of advanced technology products and solutions for Scientific Research, Life & Health Science, Aerospace & Defense, Industrial Manufacturing, Semiconductor, and Microelectronics markets. Established in 1969, Newport has over 45 years of industry knowledge and expertise across a broad range of technologies allowing the company to continually deliver innovative products in the areas of lasers, photonics instrumentation, sub-micron positioning systems, vibration isolation, optical components and subsystems and precision

automation systems. These products are utilized to enhance the capabilities and productivity of its customers' manufacturing, engineering and research applications.

Ophir Optics designs and produces a full range of precision IR optics for defense, security and commercial markets, as well as optics for high power CO₂ Laser and Fiber Laser machines. With facilities totaling 128,500 ft², in North Andover, MA USA; Bucharest, Romania; and Jerusalem, Israel, we manufacture large quantities of optics quickly and cost-effectively, using automated CNC and patented diamond-turning technologies.



OPHIR OPTICS

About Ophir Optics

Areas of Expertise:

- Optical Lens Assemblies for MWIR & LWIR, Cooled and Un-cooled Cameras
- IR Optical Components (BTP)
- Optics for High Power CO₂ Industrial Lasers

Our Ophir Laser Optics Group produces a full range of OEM and replacement optics including focusing lenses, beam-delivery optics, and cavity optics. Ophir Optics provides the highest quality CO₂ optics at the best price. The second largest OEM supplier in the world, all manufacturing is done in-house using automated CNC technology assuring complete uniformity and product consistency.

Driven by innovation, we've produced a longer lasting lens, low absorption coating, called Black Magic™. Our commitment to the customer is second to none, with a global distribution and support network.

Optics for High Power Industrial Lasers

Ophir Optics produces a full range of optics of unsurpassed quality for high power industrial lasers. Our superb replacement optics and OEM optics include:

Cutting Head Optics -

Focusing Lenses: Duralens™, Black Magic™ and Clear Magic™

Mounted Lenses: EZ mount™

Beam Delivery Optics -

0° and 90° phase shift mirrors (silicon and copper), ATFR mirrors, telescope mirrors.

Cavity Optics -

Output couplers, end mirrors and total reflectors

Maintenance -

We also provide maintenance accessories such as: Cleaning Kit, EZ Clean™ - wipes, EZ Test™ - Polarizers and Cleaning holders.

* Data and information in this catalog are provided solely for informative purposes. Specifications are of typical values. Although we strive to maintain accurate and up-to date Ophir Optics catalogs, details may change without notice. Ophir accepts no responsibility or liability whatsoever with regard to the information in this catalog.

For the latest information please refer to our website:
www.co2optics.com

One-Stop-Shop Capabilities

At Ophir, we specialize in high-performance and precision optical elements and lenses for defense, security and commercial markets.

We incorporate the latest-generation technologies involved in the design and manufacturing including:

- Diamond turning machines
- CNC generators and polishers
- Automated coating chambers
- Metrology test equipment
- Laser interferometers
- Computer-generated holographic test equipment

All of our manufacturing departments are ISO 9001:2008 certified. From design to delivery, our material control, in-process testing, operator inspections and final inspections assure that our products meet the highest specifications and quality standards.

We are dedicated to providing the latest technology and highest-quality products at the best possible value.

R&D

Our R&D department designs and develops lenses while constantly improving manufacturing techniques.

CNC Polishing

Our CNC polishing department produces optical components including spherical elements, windows, domes, prisms and mirrors from all known raw materials in the IR spectrum.

Diamond Turning

We utilize the most advanced diamondturning and fly cutting machines. When these instruments are combined with our patented aspheric diffractive production technology, the highest levels of accuracy and surface quality are achieved across a wide range of substrates.

Optical Coating

We use a wide range of coating techniques, including thermal evaporation (resistance heating and electron-gun coating), plasma-assisted chemical vapor deposition and sputtering. Our highly abrasion-resistant Anti-Reflective coatings include several types of hard carbon coatings which provide maximum energy transmission and extremely low reflection.

QA

We are ISO 9001:2008-certified with over 30 years of operational experience and compliance with commercial, automotive and military standards (MIL-I-45208) across all levels of performance specifications.

Our QA department employs the world's most advanced testing and measurement equipment.

1-MICRON OPTICS



1-MICRON OPTICS

Tutorial



Introduction:

A fiber laser is a solid-state laser that utilizes a monolithic design for high efficiency, single-mode output, and high beam quality. The Fiber laser light is created by banks of diodes, where the light is channeled and amplified through fiber optic cable in a similar way to that used for data transfer. The laser is guided within the fiber core, and because its interaction length is so great, it experiences a very high amplification. When the amplified light exits the fiber cable, it is straightened (collimated) and then focused by a lens onto the material to be cut.

The use of fiber lasers in metal processing industry for cutting applications is becoming increasingly popular due to the

advantages versus other laser technologies. Fiber lasers do an excellent job cutting metals thinner than 3 mm (0.12 in). Thin metal processing times are faster than CO₂ lasers with comparable edge quality.

Typical CO₂ laser cut edge quality for 10 mm (0.4in) Stainless steel (Courtesy of Fraunhofer ILT Aachen Germany).

Optics Elements in Fiber Laser Beam Delivery Systems

The output optical assembly of a fiber optic beam delivery system consists usually of a collimating lens, a focusing lens and a protective window. The optical lenses featured in the fiber laser cutting head are made of fused silica and are specially coated to minimize absorption and maximize transmittance of the 1 micron wavelength laser beam onto to the metal sheet.

Collimating Lens:

The collimating lens captures the highly divergent output from the optical fiber and creates a parallel (collimated) beam with reduced divergence enabling moderate propagation distances.

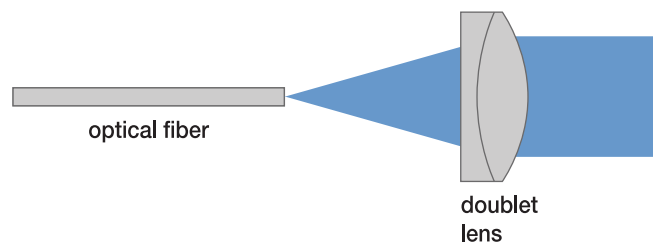

1-MICRON OPTICS

Tutorial

Focusing Lens:

Similar to other laser systems for metal processing applications, the main role of the focusing lens is to concentrate the energy of the laser beam output to spot at a specific distance (focal length) - depending on the application. The focal length - defined by the radius of curvature of the lens - is the most important feature of a focusing lens.

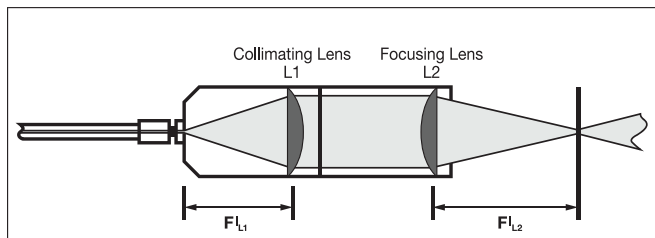

The first lens (collimator lens - L1) takes the rapidly diverging beam from the Fiber exit, and straightens, or collimates, it. This lens should be placed at a distance exactly equal to its focal length from the fiber exit face. If this is not done, the beam will not be collimated, and the imaging convention described below is void. The second lens (focusing lens - L2) acts as an objective, and focuses the beam to form an image of the fiber face.

Protective Windows:

The contamination of the focusing lens is one of the prime reasons for poor laser performance and potential downtime of laser operations. No nozzle system is perfect and some debris, fume or backspatter can occasionally reach the lens.

This situation occurs for many high power laser systems, including fiber lasers.

Collimating lenses as well as focusing lenses present in fiber laser cutting head are very sensitive to any type of contamination. For this reason, the majority of fiber laser systems employ protective windows to protect the focusing lens against contamination. The protective window is positioned in front of the focusing lens, and serves as a barrier between the lens and the metal sheet. Protective windows are the most consumed optical element in fiber laser systems.



1-MICRON OPTICS

Ophir
Fiber Optics

Fiberlens™

Ophir 1-micron Optics for Fiber Laser Systems

Ophir Fiber Laser Optics offering includes:

- Fiberlens™ - UV grade fused silica Focusing and Collimator Lenses
- UV grade fused silica **Protective Windows** used as a debris shield to protect the 1 micron lenses from contamination.

Ophir Fiberlens™ optics are the world's most innovative optics for use in high power, 1-micron Fiber Laser Systems. This family of optics is applicable for all 1 micron range application of 1030-1080nm range including fiber lasers, disc lasers and YAG lasers. Ophir Fiberlens™ optics deliver the best performance for 1-micron lasers thanks to ultra-low absorption material (<100 ppm at 1.03-1.08 microns), tight focal length tolerances ($\pm 0.5\%$) and a laser-damage threshold >10J.

Ophir Fiberlens™ general Specifications:

Item	Specification
Reflection, maximum per surface	0.2% (1030 – 1070nm)
Absorption, maximum	100 ppm
Laser Induced Damage Threshold, minimum	1 GW/cm ² at 1064nm, 20ns pulse, 10Hz repetition
Angle of Incidence, unpolarized	0 – 20 degrees
Transmission, minimum (both sides quoted)	95% (650 – 670nm)

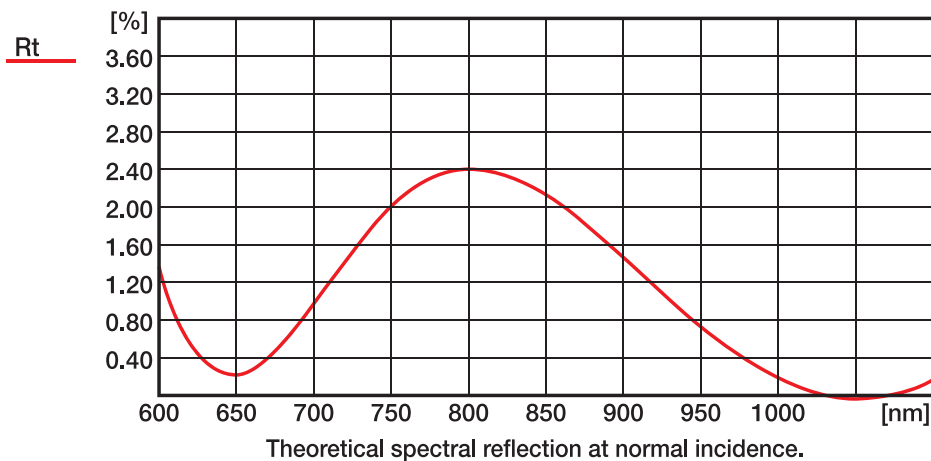

1-MICRON OPTICS

Ophir
Fiber Optics

Fiberlens™

Common Fiberlens™

(Collimator and Focusing Lenses) Offered by Ophir:

Ophir Part Number	Coating	Diameter (Inch)	Diameter (mm)	Focal Length (FL) (Inch)	Edge Thickness (ET) (mm)
632284-117	AR/AR	1.50	38.1	7.50	7.0
631699-117	AR/AR	1.50	38.1	5.00	7.0
631931-117	AR/AR	1.18	30.0	-13.50	5.8
631932-117	AR/AR	1.18	30.0	3.56	3.1
631933-117	AR/AR	1.18	30.0	-26.73	5.5
631934-117	AR/AR	1.18	30.0	3.37	2.9
632291-117	AR/AR	1.50	38.1	7.09	3.0
632292-117	AR/AR	1.50	38.1	8.66	3.3
632294-117	AR/AR	2.00	50.8	5.9	11.6
632331-117	AR/AR	1.18	30.0	7.87	3.7
632754-117	AR/AR	1.00	25.4	-8.00	6.0

1-MICRON OPTICS

Ophir
FiberOptics

Protective
Windows

Common Protective Windows Offered by Ophir:

Ophir Part Number	Coating	Diameter (Inch)	Diameter (mm)	Edge Thickness (ET) (mm)
632445-117	AR/AR	1.00	25.4	3
632498-117	AR/AR	1.97	50.0	2
632252-117	AR/AR	0.88	22.35	4
632251-117	AR/AR	1.34	34.0	5
632336-117	AR/AR	1.00	25.4	4
632713-117	AR/AR	2.17	55.0	1.5
632755-117	AR/AR	1.26	32.0	6.35
632851-117	AR/AR	1.42	36.0	5
632757-117	AR/AR	0.47	12.0	2



CUTTING HEAD OPTICS



CUTTING HEAD OPTICS

Tutorial

Lens Types, Focal Length and Mounting Distance

In general, there are two types of focusing lenses: Plano-convex and Meniscus lenses. Plano-convex have one convex surface (convex = dome-like curvature) and one flat surface. Meniscus lenses have one convex surface and one concave surface (concave = hollow curvature).

In most laser cutting machines, meniscus lenses are used because they produce a smaller focus diameter (see next section). In some machines, plano-convex lenses are used because their production costs are a little bit lower.

For a laser user who thinks about replacing a plano-convex lens by a meniscus lens, it is important to check if the focus position can be adjusted correctly. The focus position is the distance between the focus and the so-called principal plane – also known as the 'Focal Length', the principal plane is defined according to a scientific rule and is located at the optical center of the lens.

Therefore, even if a plano-convex lens and a meniscus lens have same diameter, thickness and focal length, the focus position of the meniscus lens can be several mm higher if compared to the plano-convex lens.

For checking the position of the focus in a laser cutting head, it is much more useful to know the "Mounting Distance" of the lens.

Mounting distance is defined as the distance between the edge of the lower surface and the focal plane and therefore connected directly to the position of the focus within the cutting head.

If the mounting distance of a replacement lens is different from the mounting distance of the original lens, it might happen that the focus position is shifted such that it cannot be corrected within the adjustment range of the cutting head.

On the other hand, it is possible to extend the adjustment range by using lenses with different mounting distances.

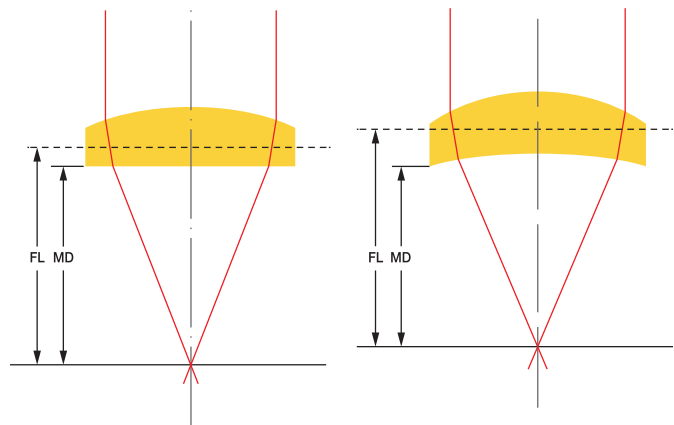

FL = focal length
(principal plane < > focal plane)
MD = mounting distance
(edge of lower surface < > focal plane)

Spherical Aberration

Spherical aberration means that the focus position of the outer portion of the laser beam is closer to the lens than the focus position of the inner portion (see picture below).

As a consequence, the focus diameter is not zero, but has some blur circle that can be approximated by the following formulas:

$$df = 0.0286 (d_{in})^3 / (FL)^2 \text{ (plano-convex lenses)}$$

$$df = 0.0187 (d_{in})^3 / (FL)^2 \text{ (meniscus lenses)}$$

df = focus diameter, d_{in} = diameter of incoming beam in millimeters,

FL = focal length in inches

Example: $d_{in} = 20 \text{ mm}$, $FL = 3.75"$:

>>> $df = 0.025 \text{ mm}$ (plano-convex lens)

CUTTING HEAD OPTICS

Tutorial

>>> $df = 0.017$ mm (meniscus lens)

The example shows that meniscus lenses produce smaller focus diameters than plano-convex lenses.

The difference is significant especially at large beam diameters and short focal lengths. In order to minimize this effect, meniscus lenses are used in most laser cutting systems. In most practical applications, however, there is a second and much more important effect which influences the focus diameter. It is called diffraction and is described in the next section.

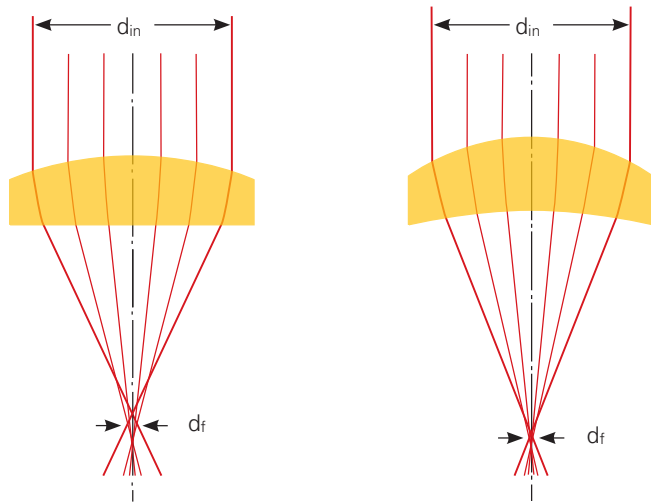

Diffraction

A laser beam is an electromagnetic wave and therefore has properties similar to water waves or sound waves. One consequence of this wave-like nature is that a laser beam cannot be focused to a sharp point. Instead the focus has a spot size which can be calculated as follows:

$$df = (4/\pi) M^2 \lambda FL / d_{in}$$

df = focus diameter, M^2 = beam quality, λ = laser wavelength, FL = focal length of focusing lens, d_{in} = Diameter of incoming beam

Examples: ($\lambda = 10.6 \mu\text{m}$, $M^2 = 2$)

Dia = 20 mm, $FL = 7.5'' \gg df = 0.13$ mm

Dia = 20 mm, $FL = 3.75'' \gg df = 0.065$ mm

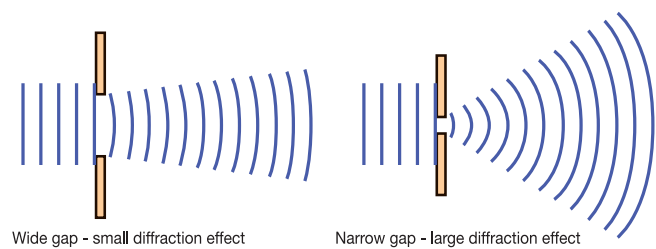

First of all, the example shows that focus diameters are much larger than the values calculated in the section above. This means that in most cutting applications, spherical aberration can be neglected. Diffraction is therefore the most important effect concerning focus diameters.

In general, the formula shows that by decreasing the focal length, the focus diameter is decreased as well, with the consequence that the intensity of the laser beam is increased.

As high laser intensity is useful in most cutting applications, focal length should be as short as possible. However, a short

CUTTING HEAD OPTICS

Tutorial

focal length has the disadvantage that the beam diameter increases rapidly above and below the focus. Therefore, maximum thickness of materials which can be cut efficiently is very limited, and the optimal focal length increases with increasing thickness of material.

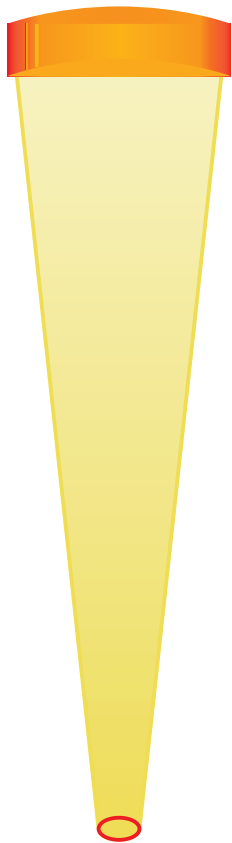

7.5" Focal Length

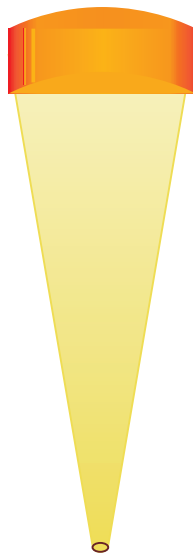

5.0" Focal Length

Absorption and Thermal Lensing

During laser operation with several kilowatts, the focusing lens is heated because it absorbs a small portion of the laser power. A new lens with standard AR coating is absorbing typically less than 0.2% of the incoming laser power. A lens with Ophir Black Magic™ coating has a maximum absorption value of 0.15%. A lens with Ophir Clear Magic™ coating has a guaranteed absorption value less than 0.13%.

During use in a laser cutting machine, absorption increases gradually due to increasing amount of dirt on the lower surface of the lens as well as changes in the molecular structure of the crystal. When the lens needs to be replaced, the absorption value usually exceeds 0.4%.

Heating of the lens causes additional surface curvature due to thermal expansion and increases the refractive index of the lens material. These effects are referred to as thermal lensing. As a consequence of these effects, the lens focal length becomes shorter, and the focus position cannot be

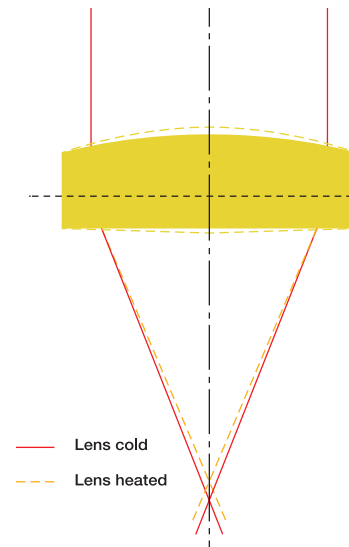

CUTTING HEAD OPTICS

Tutorial

predicted exactly because it depends on many parameters like laser power, intervals laser on/off, cleanliness of lens, and others. Therefore, use of lenses with reduced absorption can reduce thermal lensing, make the focal length more stable and therefore improve reliability of the cutting process. If there are dirt particles on the lens, the lens material is not heated uniformly, with increased heating at the areas close to the dirt particles. As a consequence, focusing properties become worse; focus diameter increases, and cutting quality decreases. Thus, once a certain "critical" amount of dirt has accumulated on the lens, it needs to be cleaned or replaced.

Benefits of Low Absorption Lenses

As laser energy passes through a focusing lens, a percentage of that energy is absorbed into the lens substrate as heat. For a standard (AR coated) lens, this absorption value is $<0.20\%$. The difference between standard and low-absorption lenses is the coating.

Low absorption coatings absorb up to 50% less energy than a standard AR coating.

Lower absorption lenses will be less affected by thermal lensing, and provide better focus stability. Low absorption coatings are easier to clean due to their tough outer layer.

Reduced absorption rate also slows the rate of thermal breakdown, and increases the life of the lens (1.5x – 2.5x).

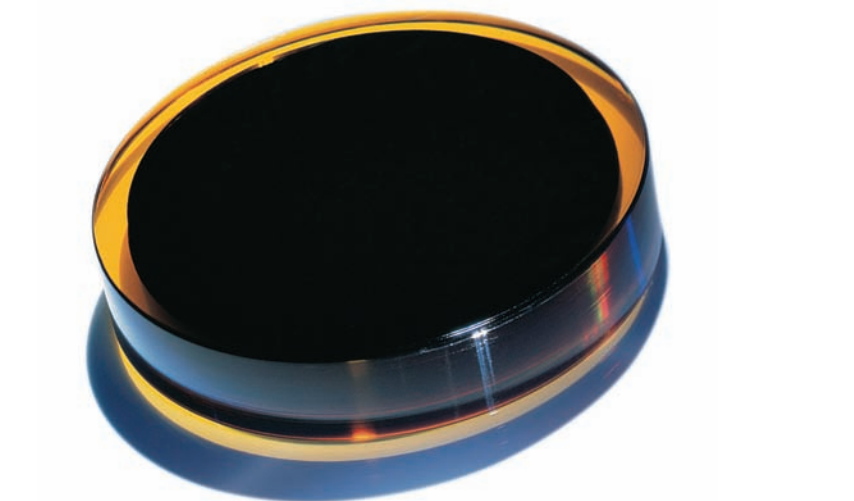

CUTTING HEAD OPTICS

CO₂ Laser Lenses

Mechanical and Coating Specifications

Ophir Optics lenses are compatible with all major laser systems in the market.

Our optics are manufactured by automated CNC technology and designed for highest durability and accuracy, assuring complete uniformity, repeatability and consistency.

These state-of-the-art manufacturing standards and technology result in the highest precision and best quality products.

As a result of our quality and capabilities, 85% of the leading laser system manufacturers are using Ophir lenses and mirrors.

Lens Mechanical Specifications

DIMENSIONS AND MECHANICAL SPECIFICATIONS

Effective Focal Length (EFL) Range	38-381mm
Edge Thickness (ET)	2-15mm
ET Tolerance	± 0.1mm
Diameter Range	10-100mm
Diameter Tolerance	+0.0 /-0.1mm
Clear Aperture	≥ 90%
Surface Irregularity	0.5 Fringe @ 0.633μm
Surface Figure	2 Fringes@ 0.633μm
ETV	< 0.025mm

CUTTING HEAD OPTICS

CO₂ Laser
Lenses

Mechanical
and Coating
Specifications

Anti-Reflection (AR) Coating Types:

Anti-reflection (AR) coating is a type of optical coating applied to the surface of lenses and other optical devices to reduce reflection.

Reflection reduction will improve the efficiency of the system since less energy will be lost.

AR coating used for CO₂ laser lenses are designed specifically for 10.6 micron wavelength, high quality coating will increase the amount of energy going through the lens and decrease the energy absorbed in the lens.

Ophir Optics produces three types of anti-reflection coatings:

- Duralens™ Absorption is <0.2% (standard)
- Black Magic™ Absorption <0.15% (low absorption)
- Clear Magic™ Absorption <0.13% (ultra-low absorption)

AR Coating Specifications:

AR Coating	Standard	LA	ULA
Brand Name	Duralens™	Black Magic™	Clear Magic™
Transmission	>99.3%	>99.35%	>99.37%
Absorption	< 0.20%	< 0.15%	< 0.13%
Reflection	<0.2%	<0.25%	<0.25%

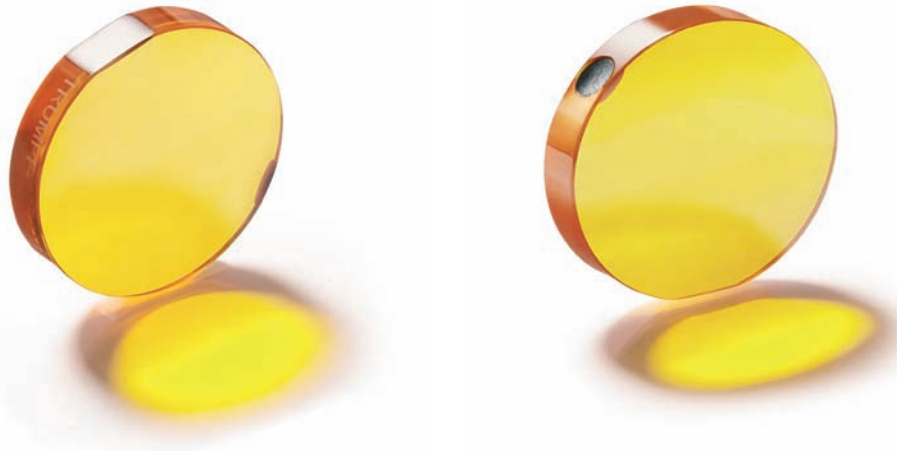

CUTTING HEAD OPTICS

CO₂ Laser
Lenses

Duralens™

High Quality Lenses for High Power CO₂ Lasers

Highlights:

- Compatible with all major laser systems in the market
- Approved and used by leading OEMs
- Designed for high durability and accuracy
 - Manufactured by automated CNC technology to assure complete uniformity
- Manufactured according to the highest precision specifications
 - Absorption $\leq 0.2\%$
- All manufacturing is done in-house



DURALENS™

CUTTING HEAD OPTICS

CO₂ Laser
Lenses

Black Magic™

Low Absorption Lenses for High Power CO₂ Lasers

- Guaranteed absorption <0.15% - constant throughout the lens lifetime
 - Maximum focus stability
- Toughest coating in the industry. Remarkable Durability
 - Best ability to withstand back spatter
 - Easier to clean and maintain
 - Resistant to humidity
- Recommended and approved by leading OEMs
 - Used for all high powered CO₂ lasers including those over 5KW
- Radioactive free coating
- Excels in cutting aluminum and stainless steel
- Best cost-benefit ratio

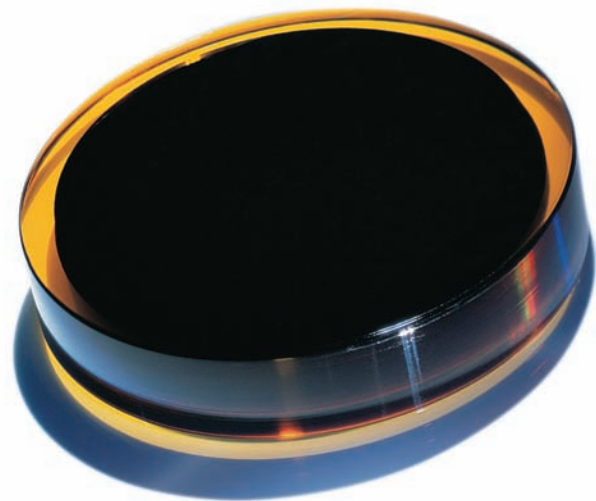

BLACK *Magic*™

CUTTING HEAD OPTICS

CO₂ Laser
Lenses

Clear Magic™

Clear Magic™ - Transparent Ultra Low Absorption Lens for High-Power CO₂ Laser Systems

Ophir offers the lowest guaranteed absorption for ZnSe lenses.

The Clear Magic's maximum Absorption level will never exceed 0.13% - and is assured for each and every lens sold.

As Ophir's Black Magic™ lenses are known for high durability and long life expectancy, we have been focusing our efforts on developing a transparent ultra low absorption lens that duplicates the unique performance of the Black Magic™ lens while providing the benefits of a transparent coating.

The new and innovative Clear Magic™ maintained the top layer of the Black Magic™, which offers better cleaning properties and the highest scratch resistance.

In addition, the Clear Magic™ allows a HeNe or diode laser alignment beam to be transmitted to the work piece and to check thermally-induced stress through polarizing filters. This coating is available in 1.5" and 2" diameter for most popular OEM systems.

CLEAR *Magic*™



CUTTING HEAD OPTICS

CO₂ Laser Lenses

Common CO₂ Lenses

Type	OPHIR PN	VERSION	DIAMETER	FOCAL LENGTH	ET
Meniscus	60866	Duralens/Black Magic	1.1"	5.0"	2.70mm
Meniscus	60924	Duralens	1.1"	2.5"	3.00mm
Plano-convex	60990	Duralens	1.1"	5.0"	3.00mm
Plano-convex	631916-117	Duralens/Clear Magic	1.5"	7.5"	7.80mm
Plano-convex	631917-117	Duralens/Clear Magic	1.5"	5.0"	7.80mm
Plano-convex	62649	Duralens/Black Magic/Clear Magic	1.5"	7.5"	7.60mm
Plano-convex	62670	Duralens/Black Magic/Clear Magic	1.5"	5.0"	7.60mm
Meniscus	62709	Duralens/Black Magic/Clear Magic	1.5"	5.0"	9.00mm
Meniscus	62710	Duralens/Black Magic/Clear Magic	1.5"	7.5"	9.00mm
Meniscus	61982	Duralens/Black Magic/Clear Magic	1.5"	5.0"	7.40mm
Meniscus	61983	Duralens/Black Magic/Clear Magic	1.5"	7.5"	7.40mm
Meniscus	61960	Duralens/Black Magic/Clear Magic	1.5"	10.0"	7.40mm
Meniscus	61961	Duralens/Black Magic/Clear Magic	1.5"	9.0"	7.40mm
Meniscus	61962	Duralens/Black Magic/Clear Magic	1.5"	3.75"	7.40mm
Meniscus	60616	Duralens/Black Magic/Clear Magic	1.5"	7.5"	9.00mm
Meniscus	631079-117	Duralens/Black Magic/Clear Magic	1.5"	5.0"	9.00mm
Plano-convex	62728	Duralens/Black Magic/Clear Magic	2.0"	5.0"	7.90mm
Plano-convex	62729	Duralens/Black Magic/Clear Magic	2.0"	7.5"	7.90mm
Plano-convex	61405	Duralens/Black Magic/Clear Magic	2.0"	7.5"	9.65mm
Plano-convex	61019	Duralens/Black Magic/Clear Magic	2.0"	5.0"	9.65mm
Meniscus	60698	Duralens/Black Magic/Clear Magic	2.0"	7.5"	9.65mm

CUTTING HEAD OPTICS

CO₂ Laser
Lenses

Common CO₂
Lenses

Meniscus	62102	Duralens/Black Magic/Clear Magic	2.0"	10.0"	9.65mm
Plano-convex	630909-117	Duralens/Black Magic	2.5"	8.75"	7.90mm
Plano-convex	61690	Duralens/Black Magic	2.5"	10.0"	9.90mm
Meniscus	632987-117	Duralens/Clear Magic	40mm	155mm	7.58mm
Meniscus	631089-117	Duralens	50mm	175mm	8.9mm
Meniscus	631088-117	Duralens	50mm	250mm	8.9mm
Meniscus	62440	Duralens	50mm	175mm	8.9mm
Meniscus	62439	Duralens	50mm	250mm	8.9mm
Meniscus	631091-117	Duralens	40mm	130mm	7.5mm
Meniscus	631090-117	Duralens	40mm	250mm	7.5mm



CUTTING HEAD OPTICS



CO₂ Laser
Lenses

EZ Mount™

Reusable Lens Mounts for Amada CO₂ Laser Equipment

EZ-Mount™ enables operators to change a lens, without replacing the mount, on any Amada machine.



Without any screws or small springs to contend with, EZ-Mount™ features a turn-to-open mechanism enabling quick, safe removal of lenses for on-the-spot cleaning, focal length adjustment or replacement. With EZ-Mount™, an O-Ring replaces the potentially toxic indium wire used in traditional mounts. It is also more cost-effective than traditional mounts because it is completely reusable and saves time on lens maintenance

EZ Mount Technical Details and typical parts							
Outer dia	Lens PN	Lens Di- ameter	ET	FL	PLCX / Men	Assembly PN	Photo
64mm	62649	1.5"	7.6mm	7.5"	PLCX	6514206	
	62670		7.6mm	5.0"	PLCX	6514205	
	61982		7.4mm	5.0"	MEN	6514204	
	61983		7.4mm	7.5"	MEN	6514202	
45mm	60905	1.5"	7.6mm	5.0"	PLCX	6521601	
	60906		8.0mm	7.5"	PLCX	6521603	
	61983		7.4mm	7.5"	MEN	6521605	
	61982		7.4mm	5.0"	MEN	6521607	
64mm	60991	2.0"	9.6mm	5.0"	MEN	6516401	
	60911		9.6mm	7.5"	MEN	6516403	
	60992		9.6mm	10.0"	MEN	6516404	
	61019		9.6mm	5.0"	PL/CX	6516405	
	61405		9.6mm	7.5"	PL/CX	6516406	
	62102		9.6mm	10.0"	PL/CX	6516407	

CUTTING HEAD OPTICS

CO₂ Laser
Lenses

EZ Mount™

63.6mm	62649	1.5"	7.8mm	7.5"	PLCX	680003-001	
	61983		7.4mm		MEN	680003-002	
	62649LA		7.6mm		PL/CX	680003-003	
	61983LA		7.6mm		MEN	680003-004	
	62649ULA		7.6mm		PLCX	680003-005	
	61983ULA		7.4mm		MEN	680003-006	
63.6mm	62670	1.5"	7.6mm	5.0"	PLCX	680004-001	
	62670LA		7.6mm		PLCX	680004-003	
67mm	61019	2.0"	9.6mm	5.0"	PLCX	680205-001	
	61019ULA		9.6mm		PLCX	680205-002	
67mm	61405	2.0"	9.6mm	7.5"	PLCX	680100-001	
	61405LA		9.6mm		PLCX	680100-002	
	61405ULA		9.6mm		PLCX	680100-005	
67mm	630911-117	2.0"	9.6mm	10.0"	PLCX	680154-001	
	630911-117ULA		9.6mm		PLCX	680154-002	

BEAM DELIVERY OPTICS

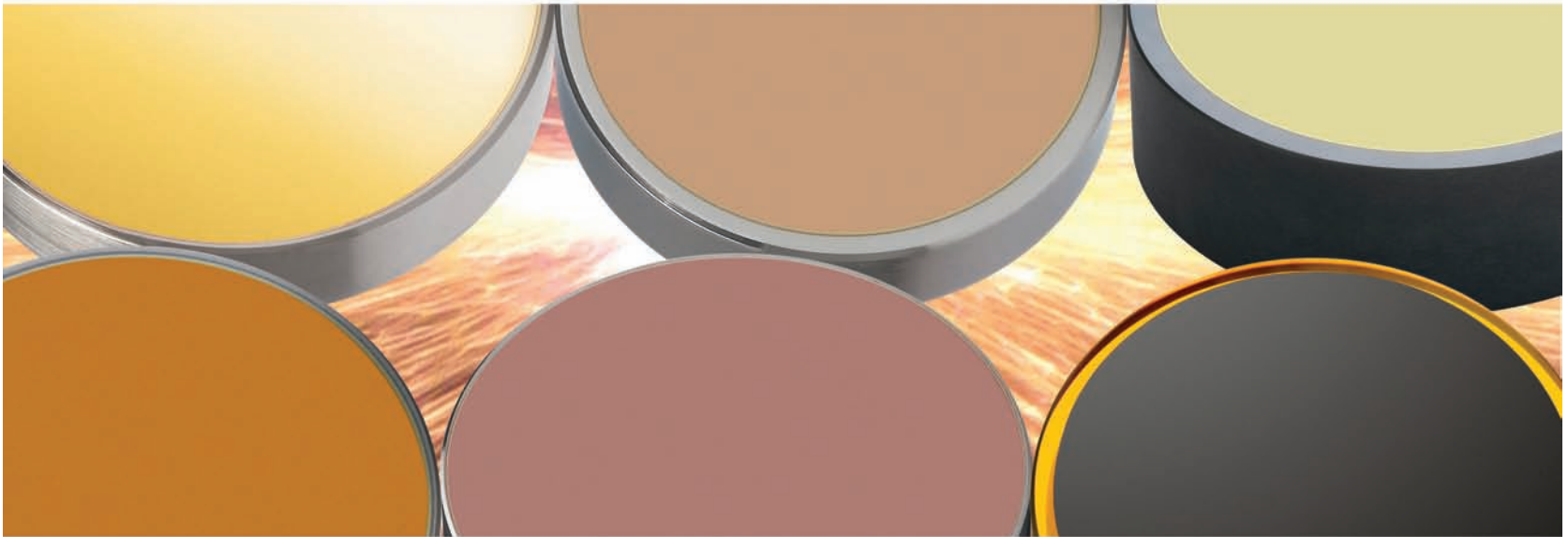

BEAM DELIVERY OPTICS

Tutorial

In the beam delivery section of a laser machining system, the laser beam is transferred from the laser cavity to the working head. In principle, two moveable mirrors would be sufficient in a 2D-machine for guiding the laser beam to any point on the worksheet. In modern 2D-machines and especially in 3D-machines, however, the beam delivery section has additional functions which require additional mirrors with specific properties.

In order to optimize function of these mirrors, different substrate materials are used – the most common ones are silicon (Si) and copper (Cu). Silicon mirrors are light weight and are therefore preferred in flying optics where high accelerations are needed. Copper has high thermal conductivity and channels for cooling water can be included directly into the mirrors. Therefore, copper mirrors are preferred if internal cooling is important, for example in machines with very high laser power. The optical performance properties of a mirror (reflectance, phase shift, etc) are determined by its coating. In order to realize different mirror functions, different coatings are needed.



BEAM DELIVERY OPTICS

Specifications

Typical Mechanical Specifications - Beam Delivery Mirrors

Material	Silicon (Si), Copper (Cu)
Surface Quality	10-5 scratch and dig
Thickness Tolerance	±0.25mm
Diameter Tolerance	+0 / -0.12mm
Mechanical Wedge	<3' (arc minutes)
Power	2 Fringes @ 0.633µm
Irregularity	1 Fringes @ 0.633µm
S1 / S2 Radius	Plano / Plano

Coating Specifications for Cu and Si Beam Delivery Mirrors*

Type	%R@10.6	%S-Pol@10.6	%P-Pol@10.6	%R@Visible	Phase Shift Tolerance
ZPS-HR	99.70%	99.80%	99.60%	630-670nm ≥80% 900-1000nm >55%	0° ±2°
ZPS	99.50%	N/A	N/A	630-660nm ≥80%	0° ±2°
MMR-P	99.85%	99.90%	99.80%	630-670nm ≥65%	0° ±2°
90PS	98%	N/A	N/A	630-670nm ≥80%	90° ±2°
90PS-HR	99%	N/A	N/A	N/A	90° ±2°
ATFR-HR	N/A	99%	≤1%	630-670nm ≥80%	N/A

*Specifications are for AOI of 45°

BEAM DELIVERY OPTICS

Folding Mirrors

Coating Types

Zero Phase Shift Mirrors

In most laser machines, one or several mirrors are used to deliver the laser beam from the cavity to the working head. Usually, each mirror reflects the laser beam by an angle of 90°. corresponding to an angle of incidence of 45°. Reflectance of these mirrors should be as high as possible in order to minimize losses of laser power; in addition, phase shift between the s- and p-polarized components of the reflected beam should be as low as possible in order to avoid disturbing the polarization of the laser beam. Mirrors with such properties are called zero phase mirrors.

Zero Phase Shift High Reflection Mirrors

Ophir Optics new ZPS-HR high reflection coating, demonstrates our innovation and commitment to constantly enhancing our optics performance.

The best benefit of the ZPS-HR coating is lower absorption by 40% versus standard ZPS / TRZ coating.

Maximum absorption of the ZPS-HR version coating is 0.3%, an improvement to the standard ZPS absorption level of 0.5%.

MMR-P

MMR-P coating can be used as cavity optics or ZPS (TRZ) and allows for the highest total random polarization reflection available. It can also be applied to a level-changing mirror in two-tiered resonator systems. Our MMR-P coating keeps the same capabilities of phase shift (tolerance of +/- 2 degree) and high reflection of visible light to enable clear observation of HeNe laser or diode laser beam reflection for alignment, location indication, etc.

Reflection Spectrum of Typical Bending Mirror Coatings

Reflection Spectrum of Common Bending Mirror Coatings

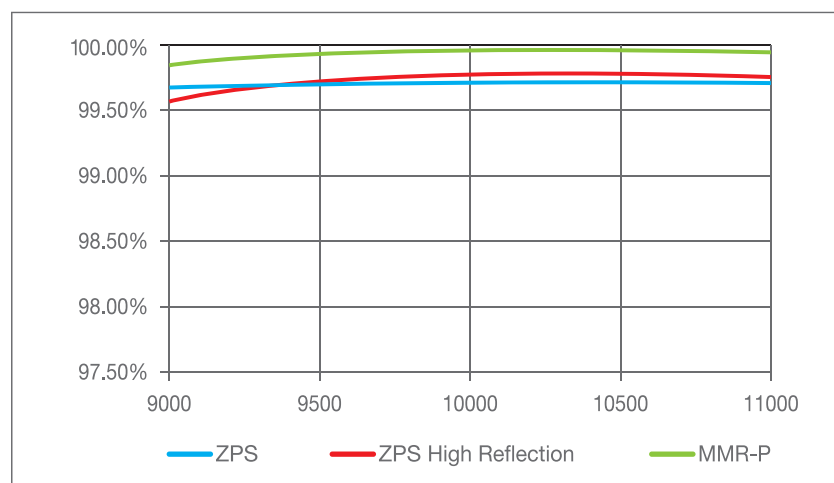

BEAM DELIVERY OPTICS

Folding
Mirrors

Common
Mirrors

Common Zero Phase Shift Mirrors

Optics Type	Material	Coating	Ophir Part Number	Diameter (Inch)	Diameter (mm)	Edge Thickness (Inch)	Edge Thickness (mm)
0-Phase Shift Copper Mirror	Cu	ZPS	631829-117	1.10	27.9	0.236	6.00
0-Phase Shift Copper Mirror	Cu	ZPS	631243-117	1.50	38.1	0.315	8.00
0-Phase Shift Copper Mirror	Cu	ZPS	630707-117	1.97	50.0	0.394	10.00
0-Phase Shift Copper Mirror	Cu	ZPS	630783-117	1.97	50.0	0.394	10.00
0-Phase Shift Copper Mirror	Cu	ZPS	631323-117	2.00	50.8	0.200	5.08
0-Phase Shift Copper Mirror	Cu	ZPS	631185-117	2.00	50.8	0.375	9.53
0-Phase Shift Copper Mirror	Cu	ZPS-HR	630189-117	2.25	57.2	0.394	10.00
0-Phase Shift Copper Mirror	Cu	ZPS-HR	630708-117	2.36	60.0	0.394	10.00
0-Phase Shift Copper Mirror	Cu	ZPS	631039-117	2.36	60.0	0.591	15.00
0-Phase Shift Copper Mirror	Cu	ZPS	631281-117	2.50	63.5	0.394	10.00
0-Phase Shift Copper Mirror	Cu	ZPS	631305-117	2.95	75.0	0.591	15.00
0-Phase Shift Copper Mirror	Cu	ZPS-HR	633032-117	3.00	76.2	0.500	12.70
0-Phase Shift Copper Mirror	Cu	ZPS	631038-117	3.00	76.2	0.600	15.00
0-Phase Shift Silicon Mirror	Si	ZPS-HR	632791-117	1.00	25.4	0.236	6.00
0-Phase Shift Silicon Mirror	Si	ZPS-HR	630065-117	1.50	38.1	0.160	4.06
0-Phase Shift Silicon Mirror	Si	ZPS	630069-117	2.00	50.8	0.375	9.53
0-Phase Shift Silicon Mirror	Si	ZPS	630714-117	2.00	50.8	0.200	5.08
0-Phase Shift Silicon Mirror	Si	ZPS	61811	2.00	50.8	0.400	10.16
0-Phase Shift Silicon Mirror	Si	ZPS-HR	631964-117	2.50	63.5	0.250	6.35
0-Phase Shift Silicon Mirror	Si	ZPS	62239	2.68	68.1	0.800	20.32
0-Phase Shift Silicon Mirror	Si	ZPS	630390-117	3.00	76.2	0.250	6.35

BEAM DELIVERY OPTICS

Folding Mirrors

Common Mirrors

0-Phase Shift Water-Cooled Copper Mirror	Cu WC	ZPS	61792	1.97	50.0	0.984	25.00
0-Phase Shift Water-Cooled Copper Mirror	Cu WC	ZPS	630631-117	2.00	50.8	2.126	54.00
0-Phase Shift Water-Cooled Copper Mirror	Cu WC	ZPS	631181-117	3.15X2.36	80X60	0.787	20.00
0-Phase Shift Water-Cooled Copper Mirror	Cu WC	ZPS	631295-117	2.36	60.0	0.984	25.00
0-Phase Shift Water-Cooled Copper Mirror	Cu WC	ZPS-HR	631369-117	2.76	70.0	0.984	25.00
0-Phase Shift Water-Cooled Copper Mirror	Cu WC	ZPS-HR	631029-117	2.00	50.8	0.984	25.00
Total Reflector Copper Mirror	Cu	MMR-P	630328-117	2.00	50.8	0.375	9.53
Total Reflector Silicon Mirror	Si	MMR-P	62391	1.50	38.10	0.375	9.53
Total Reflector Silicon Mirror	Si	MMR-P	630919-117	2.00	50.80	0.200	5.08
Total Reflector Water-Cooled Copper Mirror	Cu WC	MMR-P	631943-117	1.97	50.0	0.984	25.00
Total Reflector Water-Cooled Copper Mirror	Cu WC	MMR-P	631549-117	1.97	50.0	0.984	25.00
Total Reflector Water-Cooled Copper Mirror	Cu WC	MMR-P	631963-117	1.50	38.1	0.984	25.00

BEAM DELIVERY OPTICS

Phase Retarders

Coating Types

90° Phase Shift Mirrors

Most CO₂ lasers produce a laser beam which has linear polarization. For cutting metal sheets, however, a beam with circular polarization is ideal for cutting properties to be independent of cutting direction.

For converting a beam with linear polarization into a beam with circular polarization, a 90° ($\lambda/4$) phase shift mirror (sometimes called Phase retarder or $\lambda/4$ -mirror) can be used. This mirror has a special coating which produces a phase shift of 90° between the s-and p-polarized components of the reflected beam. If the incoming beam has both components with same intensity and phase (corresponding to random polarization), the reflected beam has phase shift of 90° between both components (corresponding to circular polarization).

90° Phase Shift High Reflection Mirrors

The function of the 90° Phase Shift High Reflection mirrors in a high power CO₂ laser system is similar to the standard 90° Phase Shift mirrors but has higher reflection resulting in less power loss and increased life expectancy.

This is an improvement of our standard 90° phase shift coating; reducing absorption level by 50% and setting it to be lower than 1%.

This superior absorption level is achieved with no compromise in the phase shift performance (tolerance +/- 2 degrees) or visible light (630-670 nm) reflection.

This coating becomes our standard for 90° phase shift mirrors.

Reflection Spectrum of 90° phase shift Mirrors Coatings

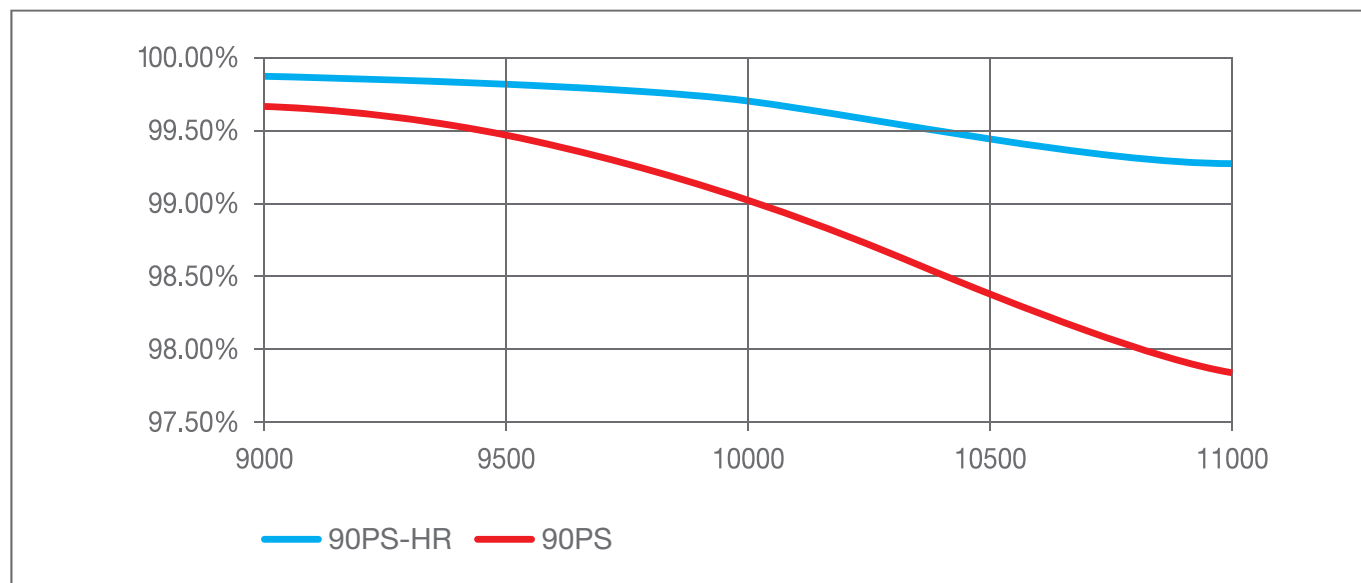

BEAM DELIVERY OPTICS

Phase
Retarders

Common
Mirrors

Common 90° Phase Shift Mirrors

Optics Type	Material	Coating	Ophir Part Number	Diameter	Optics Type	Material	Coating
90°-Phase Shift Copper Mirror	Cu	90PS-HR	631859-117	1.50	38.1	0.250	6.35
90°-Phase Shift Copper Mirror	Cu	90PS-HR	631322-117	2.00	50.8	0.200	5.08
90°-Phase Shift Copper Mirror	Cu	90PS-HR	630706-117	2.00	50.8	0.375	9.53
90°-Phase Shift Copper Mirror	Cu	90PS-HR	631641-117	2.00	50.8	0.394	10.00
90°-Phase Shift Copper Mirror	Cu	90PS-HR	631722-117	3.00	76.2	0.591	15.00
90°-Phase Shift Copper Mirror	Cu	90PS-HR	630781-117	1.97	50.0	0.394	10.00
90°-Phase Shift Copper Mirror	Cu	90PS-HR	631735-117	2.36	60.0	0.394	10.00
90°-Phase Shift Copper Mirror	Cu	90PS-HR	630914-117	2.36	60.0	0.591	15.00
90°-Phase Shift Copper Mirror	Cu	90PS-HR	631380-117	2.68	68.0	0.800	20.32
90°-Phase Shift Copper Mirror	Cu	90PS-HR	631485-117	2.95	75.0	0.591	15.00
90°-Phase Shift Silicon Mirror	Si	90PS-HR	61055	1.97	50.0	0.394	10.00
90°-Phase Shift Silicon Mirror	Si	90PS-HR	630715-117	2.00	50.8	0.200	5.08
90°-Phase Shift Silicon Mirror	Si	90PS-HR	62238	2.68	68.1	0.800	20.32
90°-Phase Shift Silicon Mirror	Si	90PS-HR	630068-117	3.00	76.2	0.25	6.35
90°-Phase Shift Water-Cooled Copper Mirror	Cu WC	90PS-HR	632844-117	1.97	50.0	0.984	25.00
90°-Phase Shift Water-Cooled Copper Mirror	Cu WC	90PS-HR	631073-117	2.00	50.8	2.126	54.00
90°-Phase Shift Water-Cooled Copper Mirror	Cu WC	90PS-HR	631296-117	2.36	60.0	0.984	25.00
90°-Phase Shift Water-Cooled Copper Mirror	Cu WC	90PS-HR	631370-117	2.76	70.0	0.984	25.00
90°-Phase Shift Water-Cooled Copper Mirror	Cu WC	90PS-HR	631182-117	3.15X2.36	80X60	0.787	20.00
90°-Phase Shift Water-Cooled Copper Mirror	Cu WC	90PS-HR	632649-117	2.56	65.0	1.299	33.00

BEAM DELIVERY OPTICS

ATFR Mirrors

Coating Type & Common Mirrors

ATFR (Absorbing Thin Film Reflector)

High Reflection Mirrors

In some laser cutting processes, there is considerable risk that some portion of the laser beam is reflected at the work piece and returned into the laser cavity. There, it might disturb laser operation. In order to avoid this problem, ATFR mirror can be inserted in the beam line. Such a mirror has high reflectance (typically 99%) for s-polarized radiation and low reflectance (typically less than 1%) for p polarized radiation.

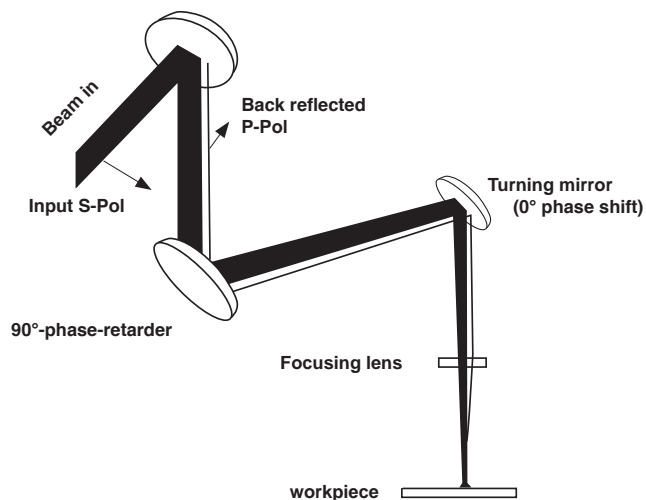

Common ATFR-HR Mirrors

Optics Type	Material	Coating	Ophir Part Number	Diameter (Inch)	Diameter (mm)	Edge Thickness (ET) (Inch)	Edge Thickness (ET) (mm)
AFTR Copper Mirror	Cu	ATFR-HR	630915-117	1.97	50.00	0.394	10.00
AFTR Copper Mirror	Cu	ATFR-HR	631347-117	2.00	50.80	0.375	9.53
AFTR Copper Mirror	Cu	ATFR-HR	62576	2.36	60.00	0.591	15.00
AFTR Copper Mirror	Cu WC	ATFR-HR	632594-117	2.36	60.00	0.984	25.00
AFTR Copper Mirror	Cu WC	ATFR-HR	631715-117	1.97	50.00	0.984	25.00
AFTR Copper Mirror	Cu WC	ATFR-HR	631853-117	2.76	70.00	0.984	25.00

Telescopic Mirrors

In many applications, the small diameter of the output beam produced by the laser cavity is not convenient because the beam has high divergence and high power density. In order to avoid subsequent problems, the beam diameter can be increased by using a telescope consisting of two mirrors – one with a convex surface and one with a concave surface. Such telescope mirrors are usually made of copper.

For these mirrors we use mainly MMR-P coating to ensure high reflection and high laser damage threshold performance. **MMR-P** coating can be used also as total reflector or ZPS (TRZ) and allows for the highest total random reflection available. It can also be applied to a level-changing mirror in two-tiered resonator systems. MMR-P coating maintains the same phase shift performance (tolerance of +/- 2 degrees) and high reflection of visible light to enable transmission of a HeNe laser or diode laser beam to be used for alignment, location indication, etc.

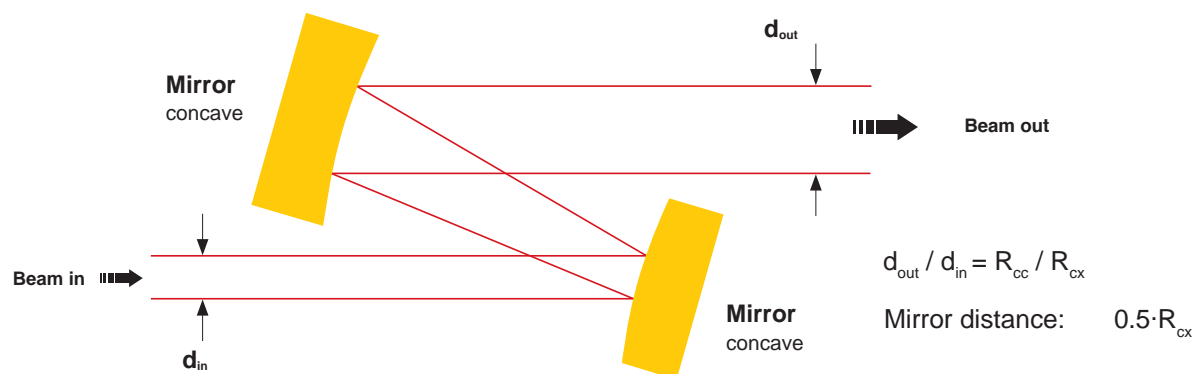

BEAM DELIVERY OPTICS

Telescopic
Mirrors

Typical
Specifications

Typical Mechanical Specifications - Copper Telescopic Mirrors

Material	Copper (Cu)
Surface Quality Thickness	10-5 scratch and dig
Thickness Tolerance	+0.0 / -0.1mm
Diameter Tolerance	+0.0 / -0.1mm
Mechanical Wedge	<3' (arc minutes)
Power	2 Fringe @ 0.633 μ m
Irregularity	1 Fringe @ 0.633 μ m

Coating Specifications - Copper Telescopic Mirrors

Due to the high power density (incident mainly on the convex mirrors) telescope mirrors are coated with high reflection and high damage threshold coatings such as MMR or MMR-P coatings. Using ZPS high reflection coating is possible as well.

BEAM DELIVERY OPTICS

Telescopic
Mirrors

Common
Mirrors

Common Telescopic Mirrors

Optics Type	Material	Coating	Ophir Part Number	Diameter (Inch)	Diameter (mm)	Edge Thickness (ET) (Inch)	Edge Thickness (ET) (mm)	Radius of Curvature/ Shape (Meters)
0-Phase Shift Copper Mirror	Cu	MMR	632027-117	1.50	38.1	0.236	6.00	15.0CC
Telescope Copper Mirror	Cu	MMR	631863-117	1.97	50.0	0.394	10.00	2.25CX
Telescope Copper Mirror	Cu	MMR	631650-117	1.97	50.0	0.394	10.00	1.0CX
Telescope Copper Mirror	Cu	MMR	631196-117	1.97	50.0	0.394	10.00	3.0CC
Telescope Copper Mirror	Cu	MMR	631882-117	1.97	50.0	0.394	10.00	3.25CC
Telescope Copper Mirror	Cu	MMR	631142-117	1.97	50.0	0.394	10.00	2.0CC
Telescope Copper Mirror	Cu	MMR	631141-117	1.97	50.0	0.394	10.00	1.4CX
Telescope Copper Mirror	Cu	MMR	631162-117	1.97	50.0	0.375	9.53	1.73CX
Telescope Copper Mirror	Cu	MMR	631163-117	1.97	50.0	0.375	9.53	2.28CX
0-Phase Shift Copper Mirror	Cu	ZPS	631744-117	1.97	50.0	0.375	9.53	1.737CX
Telescope Copper Mirror	Cu	MMR-P	632646-117	1.97	50.0	0.394	10.00	7.2CC
Telescope Copper Mirror	Cu	MMR-P	632645-117	1.97	50.0	0.394	10.00	6.7CC
Telescope Copper Mirror	Cu	PLM-W	631053-117	1.97	50.0	0.394	10.00	100.0CC
Telescope Copper Mirror	Cu	MMR	631052-117	1.97	50.0	0.394	10.00	100.0CC

BEAM DELIVERY OPTICS

Telescopic Mirrors

Common Mirrors

Telescope Copper Mirror	Cu	PLM-W	631051-117	1.97	50.0	0.394	10.00	80.0CC
Telescope Copper Mirror	Cu	MMR	631050-117	1.97	50.0	0.394	10.00	80.0CC
Telescope Copper Mirror	Cu	MMR-A	631245-117	2.0"	50.8	0.394	10.00	5.7CX
Telescope Copper Mirror	Cu	MMR-A	631246-117	2.0"	50.8	0.394	10.00	6.0CC
Telescope Copper Mirror	Cu	MMR-P	632694-117	2.0"	50.8	0.394	10.00	5.0CX
Telescope Copper Mirror	Cu	MMR-P	631713-117	2.0"	50.8	0.394	10.00	6.3CC
Telescope Copper Mirror	Cu	MMR-P	631710-117	2.0"	50.8	0.394	10.00	6.6CC
Telescope Copper Mirror	Cu	MMR-P	631706-117	2.0"	50.8	0.394	10.00	5.3CC
Telescope Copper Mirror	Cu	MMR-P	631707-117	2.0"	50.8	0.394	10.00	4.3CX

u

CAVITY OPTICS

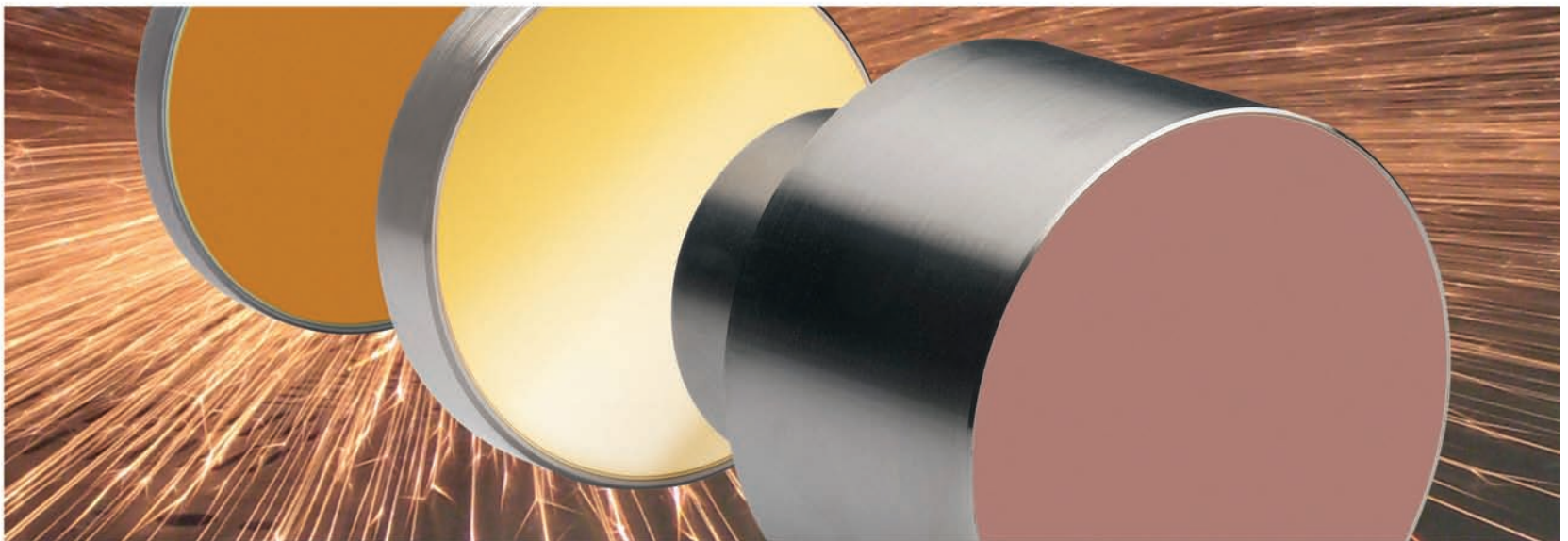

In the cavity of a CO₂ laser, carbon dioxide molecules are excited by a gas discharge. This excitation energy is fed into a laser beam if it has sufficient intensity. For building up this intensity, mirrors are placed at both ends of the discharge such that the laser beam is reflected back and forth many times. Such an arrangement is called a laser cavity.

In real cavities, both mirrors have some transmittance: one of them is the output coupler where the transmitted beam constitutes the useable laser beam; the other one is the rear mirror

where the transmitted beam has very low intensity and is used for controlling purposes. For building up a laser cavity with output laser power of several kW, the total length of the discharge needs to be several meters. Covering this distance with one discharge is very problematic. Therefore, it is split up into several discharges working in line. In order to make the mechanical setup as compact as possible, the path of the laser beam within the laser cavity is “folded” several times by using total reflection or polarization lock mirrors.

Total Reflectors

Total reflectors are quite similar to turning mirrors. However, durability of the coating is more critical because the total reflectors are exposed to the gas discharge and the high laser power density inside the cavity. Therefore, the coating must have best-possible environmental resistance and low absorption in order to minimize thermal distortion.

Polarization Locking Mirrors (PLM):

Laser resonators rely on small differences in the reflectivity of fold mirrors for different polarization states to give a stable linearly polarized output. In some cases, the small reflection gaps of the total reflector mirror coatings are not enough to keep the polarization from fluctuating. Using specific properties of the materials selected in optical coating design, we are able to increase the differences in the reflection of S-polarization compared to P-polarization and achieve a truly stable “locked” polarization.

High Reflection Polarization Locking Mirrors (PLM-HR):

PLM-HR mirrors in a high power CO₂ laser cavity fulfill the same function as the standard PLM Mirrors. The advantage of the PLM-HR coating is that it reduces power loss and consequently increases component’s life expectancy.

CAVITY OPTICS

Typical Specifications

Mechanical Specifications - Cavity Mirrors Silicon Mirrors and Copper Mirrors

Materials	Silicon (Si), Copper (Cu)
Surface Quality	10-5 scratch and dig
Thickness Tolerance	±0.1mm
Diameter Tolerance	+0 / -0.12mm
Mechanical Wedge	<3' (arc minutes)
Power	2 Fringes @ 0.633µm
Irregularity	1 Fringe @ 0.633µm
S1 / S2 Radius	Plano / Plano

Total Reflector and PLM Mirrors Coating Table

Type	%R@45° @10.6	%S-Pol@45° @10.6	%P-Pol@45° @10.6	%R@45° @0.6328	Phase Shift Tolerance
MMR	99.80%	99.90%	99.75%	40%	0° ±2°
MMR-A	99.80%	99.85%	99.60%	40%	0° ±2°
MMR-H \ DEMRR	99.70%	99.80%	99.60%	630-670nm≥80%	-
MMR-P	99.85%	99.90%	99.80%	630-670nm≥80%	0°±2°
PLM	NA	99.50%	≤90%	NA	NA
PLM-W	NA	99.80%	≤90%	N/A	NA
PLM-HR	N/A	>99.9%	<93%	630-670nm≥65%	N/A

CAVITY OPTICS

Total Reflector and PLM Mirrors

Common Mirrors

Total Reflector and Polarization Locking Mirrors

Optics Type	Material	Coating	Ophir Part Number	Diameter (Inch)	Diameter (mm)	Edge Thickness (ET) (Inch)	Edge Thickness (ET) (mm)
Total Reflector Copper Mirror	Cu	MMR	630920-117	2.00	50.8	0.200	5.08
Total Reflector Copper Mirror	Cu	MMR-P	630328-117	2.00	50.8	0.375	9.53
Total Reflector Copper Mirror	Cu	MMR	630921-117	1.97	50.0	0.394	10.00
Total Reflector Copper Mirror	Cu	MMR	630922-117	2.36	60.0	0.394	10.00
Total Reflector Copper Mirror	Cu	DEMMR	630918-117	1.97	50.0	0.394	10.00
Total Reflector Silicon Mirror	Si	MMR	631708-117	1.10	27.94	0.244	6.20
Total Reflector Silicon Mirror	Si	MMR	630064-117	1.50	38.10	0.160	4.06
Total Reflector Silicon Mirror	Si	DEMMR	631854-117	1.50	38.10	0.200	5.08
Total Reflector Silicon Mirror	Si	MMR-P	62391	1.50	38.10	0.375	9.53
Total Reflector Silicon Mirror	Si	MMR	62444	1.75	44.45	0.375	9.53
Total Reflector Silicon Mirror	Si	MMR	632228-117	1.97	50.0	0.276	7.00
Total Reflector Silicon Mirror	Si	DEMMR	630917-117	2.00	50.80	0.200	5.08
Total Reflector Silicon Mirror	Si	MMR-P	630919-117	2.00	50.80	0.200	5.08
Total Reflector Silicon Mirror	Si	MMR	630780-117	2.00	50.80	0.200	5.08
Total Reflector Silicon Mirror	Si	MMR-P	631965-117	2.50	63.50	0.250	6.35
Total Reflector Water-Cooled Copper Mirror	Cu WC	MMR-P	631943-117	1.97	50.0	0.984	25.00
Total Reflector Water-Cooled Copper Mirror	Cu WC	MMR	632650-117	2.36	60.0	1.299	33.00
Total Reflector Water-Cooled Copper Mirror	Cu WC	MMR-P	632652-117	2.36	60.0	1.299	33.00
Total Reflector Water-Cooled Copper Mirror	Cu WC	MMR	631589-117	2.00	50.8	2.126	54.00
Total Reflector Water-Cooled Copper Mirror	Cu WC	MMR-P	630886-117	1.97	50.0	0.984	25.00
Total Reflector Water-Cooled Copper Mirror	Cu WC	MMR-P	631549-117	1.97	50.0	0.984	25.00

CAVITY OPTICS

Total Reflector and PLM Mirrors

Common Mirrors

Total Reflector Water-Cooled Copper Mirror	Cu WC	MMR-P	631963-117	1.50	38.1	0.984	25.00
100M Concave Polarization Locking Copper Mirror	Cu	PLM-W	631053-117	1.97	50.00	0.394	10.00
80M Concave Polarization Locking Copper Mirror	Cu	PLM-W	631051-117	1.97	50.00	0.394	10.00
Polarization Locking Copper Mirror	Cu	PLM-W	632243-117	1.97	50.00	0.394	10.00
Polarization Locking Silicon Mirror	Si	PLM HR	631294-117	1.50	38.10	0.375	9.53
Polarization Locking Silicon Mirror	Si	PLM HR	631555-117	1.97	50.00	0.354	9.00
Polarization Locking Water-Cooled Copper Mirror	Cu WC	PLM HR	631410-117	1.50	38.10	0.787	20.00
Polarization Locking Water-Cooled Copper Mirror	Cu WC	PLM-W	631160-117	2.00	50.80	2.126	54.00
Polarization Locking Water-Cooled Copper Mirror	Cu WC	PLM-W	632651-117	1.97	50.00	1.300	33.00

CAVITY OPTICS

End Mirrors and Output Couplers

Typical Specifications

End Mirrors and Output Couplers

The output coupler usually has reflectance in the range 40% to 70%. In order to optimize power and spatial profile of the laser beam, the output coupler and rear mirror have optical surfaces with well-defined radii of curvature. As the output coupler transmits a high-power laser beam, it is made of ZnSe in order to minimize absorption and thermal lensing. The end mirror usually has reflectance of 99.5% which means that the transmitted laser beam has low power. However, as absorption in the coating is higher than in the output coupler, it is more important to use a substrate material with high thermal conductivity. Therefore, Germanium (Ge) or Gallium Arsenide (GaAs) is used in most lasers.

Specifications: End Mirror

Material	Ge	GaAs
Surface Quality	10-5 scratch and big	10-5 scratch and big
Thickness Tolerance	+0/-0.1mm	+0/-0.1mm
Diameter Tolerance	+0/-0.1mm	+0/-0.1mm
Mechanical Wedge	<3' (arc minutes)	<3' (arc minutes)
Power	1F@0.633 μ m	1F@0.633 μ m
Irregulation	0.5F@0.633 μ m	0.5F@0.633 μ m
Reflection	99% / 99.5% / 99.6% / 99.7%	99.7%
Absorption	0.1%	0.1%
AOI	0°	0°
Side 2 Reflection	0.2%	0.2%
Clear Aperture	90%	90%

CAVITY OPTICS

End Mirrors and Output Couplers

Common End Mirrors

Common End Mirrors

Optics Type	Material	S1 Reflection / AR	Ophir Part Number	Diameter (Inch)	Diameter (mm)	Edge Thickness (ET) (Inch)	Edge Thickness (ET) (mm)	Surface 1 Surface 2 Radius of Curvature / Shape (Meters)
End Mirror	Ge	99.5%	61436	1.00	25.4	0.236	6.0	15.0CC / PO
End Mirror	GaAs	99.7%	631047-117	1.00	25.4	0.236	6.0	20.0CC / PO
End Mirror	GaAs	99.7%	631046-117	1.00	25.4	0.236	6.0	30.0CC / PO
End Mirror	Ge	99.5%	61993	1.10	27.9	0.22	5.6	10.0CC / 0.6CX
End Mirror	Ge	99.5%	631341-117	1.10	27.9	0.22	5.6	15.0CC / 0.6CX
End Mirror	Ge	99.6%	61406	1.10	27.9	0.22	5.6	10.0CC / PO
End Mirror	Ge	99.5%	632295-117	1.10	27.9	0.22	5.6	20.0CC / 0.6CX
End Mirror	Ge	99.6%	61407	1.10	27.9	0.22	5.6	20.0CC / PO
End Mirror	Ge	99.5%	631855-117	1.10	27.9	0.22	5.6	PO / 0.3CX - New
End Mirror	Ge	99.7%	631407-117	1.10	27.9	0.22	5.6	15.0CC / 0.75CX - New
End Mirror	Ge	99.5%	61547	1.10	27.9	0.236	6.0	20.0CC / PO
End Mirror	Ge	99.5%	631108-117	1.10	27.9	0.236	6.0	10.0CC / PO – New
End Mirror	Ge	99.6%	630916-117	1.18	30.0	0.236	6.0	30.0CC / PO
End Mirror	GaAs	99.6%	632689-117	1.18	30.0	0.236	6.0	PO / PO
End Mirror	Ge	99.5%	61543	1.50	38.1	0.315	8.0	15.0CC / PO
End Mirror	Ge	99.5%	61544	1.50	38.1	0.315	8.0	35.0CC / PO
End Mirror	Ge	99.5%	630338-117	1.50	38.1	0.315	8.0	20.0CC / PO
End Mirror	Ge	99.7%	631104-117	1.50	38.1	0.315	8.0	51.6CC / PO

CAVITY OPTICS

End Mirrors
and
Output
Couplers

Typical Output
Couplers
Specifications

Specifications - Output Couplers

Output Couplers

Materials	ZnSe
Surface Quality	10-5 scratch and dig
Thickness Tolerance	±0.2mm
Diameters Tolerance	+0/-0.1mm
Mechanical Wedge	<3' (arc minutes)
Power	1F@0.633μm
Irregularity	0.5F@0.633μm
S1 Reflection@10.6μm	30% to 70%
S1 Reflection Tolerance	±0.2%
S2 Reflection@10.6μm	0.2%

CAVITY OPTICS

End Mirrors and Output Couplers

Common Output Couplers

Common Output Couplers

Optics Type	Material	S1 Reflection / Clear Magic	Ophir Part Number	Diameter (Inch)	Diameter (mm)	Diameter (Inch)	Edge Thickness (ET) (mm)	Surface 1 Sur- face 2 Radius of Curvature / Shape (Meters)
ZnSe Output Coupler	ZnSe	17%	631758-117	1.5	38.1	0.236	6.00	10.0CC / 15.0CX
ZnSe Output Coupler	ZnSe	30%	631720-117	1.5	38.1	0.236	6.00	20.0CC / PO
ZnSe Output Coupler	ZnSe	35%	62056	1.75	44.45	0.250	6.35	20.0CC / 10.0CX
ZnSe Output Coupler	ZnSe	40%	61542	1.5	38.1	0.315	8.00	15.0CC / 7.5CX
ZnSe Output Coupler	ZnSe	40%	630337-117	1.5	38.1	0.315	8.00	20.0CC / 10.0CX
ZnSe Output Coupler	ZnSe	40%	61887	1.5	38.1	0.315	8.00	50.0CC / 25.0CX
ZnSe Output Coupler	ZnSe	40%	631109-117	1.1	27.9	0.236	6.00	10.0CC / 5.0CX
ZnSe Output Coupler	ZnSe	40%	631048-117	1.0	25.4	0.236	6.00	PO / 7.0CC
ZnSe Output Coupler	ZnSe	40%	631883-117	1.5	38.1	0.236	6.00	PO / PO
ZnSe Output Coupler	ZnSe	50%	631416-117	1.0	25.4	0.236	6.00	30.0CC / 30.0CX
ZnSe Output Coupler	ZnSe	50%	631624-117	1.0	25.4	0.236	6.00	PO / 18.0CC
ZnSe Output Coupler	ZnSe	50%	631049-117	1.0	25.4	0.236	6.00	PO / PO
ZnSe Output Coupler	ZnSe	50%	63003	1.1	27.9	0.236	6.00	20.0CC / 12.0CX
ZnSe Output Coupler	ZnSe	50%	631165-117	1.1	27.9	0.236	6.00	15.0CC / 7.5CX

CAVITY OPTICS

End Mirrors and Output Couplers

Common Output Couplers

ZnSe Output Coupler	ZnSe	50%	630924-117	1.18	29.97	0.236	6.00	30.0CC / 30.0CX
ZnSe Output Coupler	ZnSe	50%	632451-117	1.18	29.97	0.236	6.00	PO / PO
ZnSe Output Coupler	ZnSe	50%	61888	1.5	38.1	0.315	8.00	51.6CC / 25.0CX
ZnSe Output Coupler	ZnSe	50%	61884	1.5	38.1	0.315	8.00	40.0CC / 20.0CX
ZnSe Output Coupler	ZnSe	50%	632605-117	1.5	38.1	0.315	8.00	20.0CC / 10.0CX
ZnSe Output Coupler	ZnSe	55%	631712-117	1.0	25.4	0.236	6.00	30.0CC / 10.0CX
ZnSe Output Coupler	ZnSe	60%	61994	1.1	27.9	0.220	5.60	10.0CC / 5.0CX
ZnSe Output Coupler	ZnSe	60%	631856-117	1.1	27.9	0.220	5.60	10.0CC / 7.5CX
ZnSe Output Coupler	ZnSe	60%	631112-117	1.1	27.9	0.236	6.00	20.0CC / 7.5CX
ZnSe Output Coupler	ZnSe	60%	631419-117	1.1	27.9	0.236	6.00	20.0CC / 9.0CX
ZnSe Output Coupler	ZnSe	65%	61435	1.0	25.4	0.236	6.00	30.0CC / 30.0CX
ZnSe Output Coupler	ZnSe	65%	631433-117	1.1	27.9	0.220	5.60	20.0CC / 15.0CX
ZnSe Output Coupler	ZnSe	65%	631164-117	1.1	27.9	0.220	5.60	15.0CC / 10.0CX
ZnSe Output Coupler	ZnSe	65%	632463-117	1.1	27.9	0.236	6.00	30.0CC / 30.0CX
ZnSe Output Coupler	ZnSe	70%	61411	1.1	27.9	0.220	5.60	20.0CC / 20.0CX
ZnSe Output Coupler	ZnSe	70%	61546	1.1	27.9	0.236	6.00	PO / PO
ZnSe Output Coupler	ZnSe	99%	631755-117	1.5	38.1	0.236	6.00	20.0CC / PO

OPTICAL COMPONENT FABRICATION

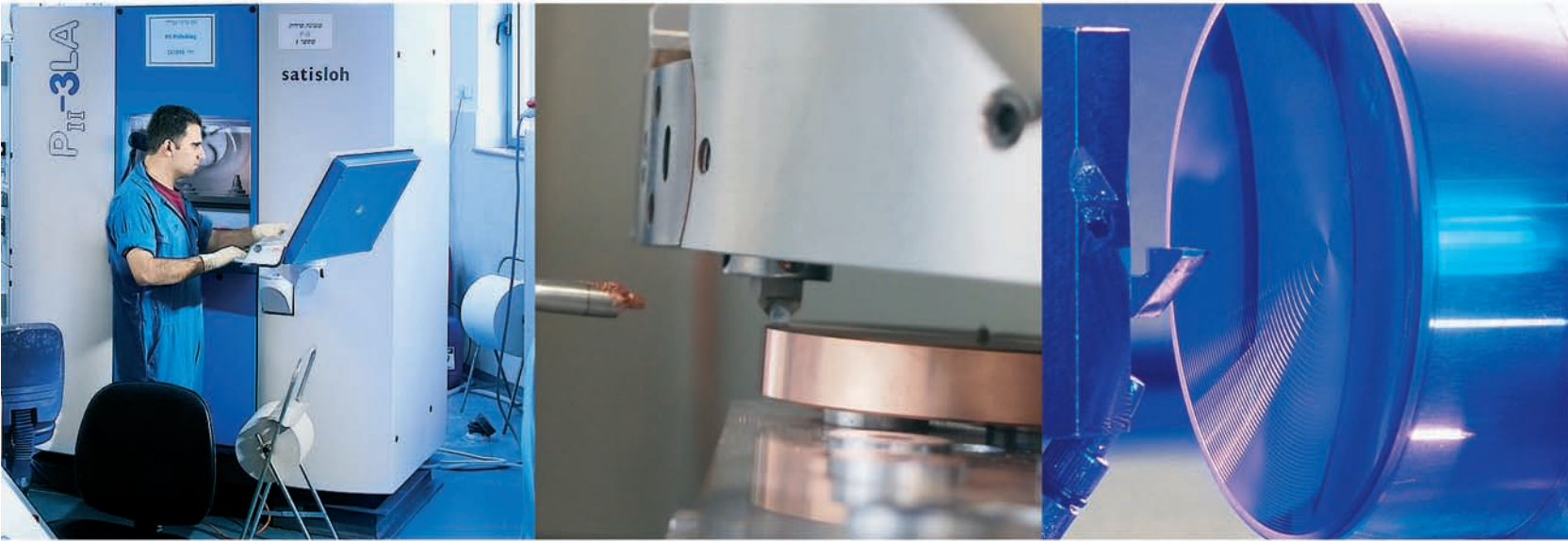

High Precision CNC Polishing

The CNC and conventional polishing department at Ophir Optics produces spherical elements, windows, domes, prisms and mirrors from all known materials for the IR spectrum and has additional capabilities in the visible range and UV spectrum. This department is unique in its abilities to produce a wide range of high precision elements, both crystals and metals, in prototype, one-off and mass production.

Over 35 Years of R&D and operational experience, unique techniques of micro-polishing have been developed to enable Ophir to provide individual process solutions for various precision optics applications in optimal cycle times with high precision, low scattering and low absorption for high power applications.

Manufacturing capabilities include the most advanced machinery for grinding, centering, shaping and polishing of optical components.

This technically advanced machinery is perfectly complemented by conventional optical manufacturing equipment, proven over many years to produce state-of-the-art precision elements.

Our unique and automated CNC machining capabilities include producing elements from a minimum diameter of 3mm to a maximum diameter of 350mm with dimensional tolerances of 0.01mm. Quality achievements include surface finish of 10-5 scratch and dig, parallelism of 1" and irregularity of $\lambda/10$ P-V at 633nm on Germanium, Silicon, Zinc Sulfide, Zinc Selenide, Titanium, Chalcogenide glasses, Calcium Fluoride, Gallium Arsenide, PMMA, Quartz, Fused Silica, and other exotic materials, as well as on most types of glass.

CNC and Conventional Polishing Capabilities

Diameter (max.)	350mm
Diameter (min.)	3mm
Diameter Tolerance	± 0.01 mm
Radius of Curvature (min.)	4mm
Centration	0.005mm
Irregularity ($\lambda @ 0.633\mu$ P-V)	$\lambda/10$
Power	$\lambda/10$
Scratch and Dig	10-5
Parallelism	1"

OPTICAL COMPONENT FABRICATION

Diamond Turning

Diamond Turning

Ophir Optics manufactures flat, spherical and aspherical mirrors, regular and water cooled, in many sizes as standard and per customer request.

Metal mirrors find wide uses in industrial laser systems. Copper is the most popular material from which to make infrared mirrors, and is the most common mirror type for CO2 laser cutting, engraving and welding.

Our Diamond Turning department uses the most advanced, sophisticated diamond turning machines available in the market today.

We have over a dozen machines including fly cutting and free-form capability.

This modern equipment, together with the department's rich experience and dedicated staff, enable Ophir to achieve the most demanding optical requirements in the entire IR substrates range such as: Copper, Aluminum, Germanium, Silicon, Zinc Selenide, Zinc Sulfide, Zinc Sulfide Multi Spectral (Cleartran), Calcium Fluoride, etc.

The department is not only equipped with the complex Diamond Turning lathes and Fly Cutters, but also known for its most advanced aspheric & diffractive testing facilities.

We have several state of the art surface scanners - Form Talysurfs and five unique Tywman Green interferometers using low cost computer generated holograms, in addition to the numerous Zygo GPI's and Zygo NewView profilometer (contact optical surface profiling).

Ophir Optics can cut from the simple to the complex, including double aspheric - diffractive lenses, for which Ophir holds a US patent, as well as free form shapes, such as toroids and off-axis mirrors.

The department's strength stems from our diligent search for increasing throughput and reducing production time. Thus, we can offer competitive prices for small batches and for high volume production, all in our high production standards.

Capabilities: Diamond Turning

Diameter	(Max) 700mm
Diameter	(Min) 5mm
Aspheric Radius accuracy	+/- 0.5 %
Roughness = Mirrors (Aluminum - Copper)	50 typical, 30 special RMS
Roughness = Aspheric Lenses	200 typical, Diffractive 300 typical RMS
Flatness typically better than	0.25um

OPTICAL COMPONENT FABRICATION

Thin Film Optical Coating

High Performance Thin Film Optical Coatings

Ophir Optics is a world leader in designing and producing high end coatings for industrial, commercial and defense applications, for a broad range of substrates.

Our broad selection of coatings is applied via wide range of coating techniques including-

Ion-assisted electron beam deposition and plasma assisted chemical vapor deposition as well as sputtering, to influence and control reflectance, transmittance, absorption and resistance.

Ophir coating chambers are operated in class 1,000 clean-room with combination of automated monitoring techniques insuring repeatable and durable process, and precise coatings.

All optical parts are cleaned by automated water-based cleaning machine to ensure the best substrate cleanliness for each and every element

We provide OEM-approved coatings from the UV to the far IR including AR (anti-reflective), beam splitters, HR (high reflective) metal coatings for superior cutting, improved per-

formance, protect highly-sensitive mirror surfaces and prolong product life.

Ophir Optics coating expert designers provide effective solutions for custom applications, many of which require original, innovative and complex designs and manufacturing technologies.

Cavity and beam delivery mirror coatings Includes: PLM, MMR, MMR-A, MMR-P and MMR-H coatings designed for better polarization control and enhanced reflectivity for internal mirrors, as well as ZPS and 90PS for beam delivery optics. Finally, the mirrors have a phase shift tolerance of ± 2 degrees, for superior cutting and cleaning capabilities.

Lens Anti-Reflection (AR) Coatings:

- AR Absorption <0.2% (standard)
- Black Magic™ Absorption guaranteed <0.15% (Low Absorption)
- Clear Magic™ Absorption guaranteed <0.13% (Ultra Low Absorption)

Selected Optical Coating	General Applications	CO ₂ Optics for Medical and industrial Lasers
FLIR Optics for 3-5μ/8-12μ	AR-V	Zero Phase Shift Mirrors
High Efficiency AR	AR Broadband	90° Phase Shift Mirror
High Durability AR	AR Double and Triple Band	AR/AR on ZnSe
Super Hard Durability	Long and short Pass Filters	Dichroic Mirrors
High Reflectivity Mirrors		Output Couplers and End Mirrors
Hard Carbon		High Reflectivity Turning Mirrors
		MMR/MMRA

For additional information please visit our website: www.ophiropt.com

OPTICAL COMPONENT FABRICATION

QA

QA

ISO 9001:2008 certified, Ophir Optics has over 30 years of experience working according to military standards across all levels of performance specification.

Our QC department uses an effective combination of the world's most advanced testing and measurement equipment as well as unique techniques developed at Ophir.

Our manufacturing processes are assured by our metrology equipment which includes Dimensional and surface testing equipment, both optical and mechanical, coupled with spectrophotometers and precision reflectivity and transmission including:

- Absorption station calibrated per ISO specifications
- Phase retardation measurement (+/- 1 degree) equipment

- Spectrophotometer- for the measurement of transmittance or reflectance
- Zygo Interferometers @ 10.6um (for measuring surface irregularities)
- Zygo Interferometer @ 630nm
- Zygo NewView - characterizing and quantifying surface roughness
- Hardness tests equipment
- Spherometer for the precise measurement of the radius of a sphere
- Environmental tests (temperature & Humidity, Adhesion, dust, Salt solubility and salt spray fog)
- LIDT via international labs and commercial testing facilities



OPTICAL COMPONENT FABRICATION

Optical Lens Assemblies

Optical Lens Assemblies

Ophir Optics has dramatically expanded its optical mechanical hardware and software design capabilities so that today we offer complete, unique and highly effective solutions for a wide variety of lens assembly projects.

Ophir Optics' competitive advantage stems from the superior production know-how of its highly qualified staff and the use of the most advanced design techniques and skills. Ophir Optics has developed a patent that led to a revolutionary breakthrough in cost-efficient lens assembly design, enabling superior performance combined with simpler assembly and fewer optical elements.

Ophir Optics lens assemblies rely on the unique combination

of state of the art optical components, aspheric and spherical lenses, together with the worlds most advanced diffractive elements, superior coatings and world class optical design ability.

Ophir Optics translates its expertise in all of these areas into high performance and unique products at competitive prices. Ophir Optics designs and produces single, dual and three-field-of-view lenses in addition to zoom lenses in 8-12 μ range.

Ophir Optics' research, development and engineering team also provides innovative, optical lens assembly solutions for special projects and applications according to the specific requirements of the customer.



OPTICAL COMPONENT FABRICATION

Research & Development

Research & Development

Ophir Optics possesses in-house optical, mechanical and electronic design capabilities. Our R&D and Engineering department designs and develops lens assemblies, while constantly improving manufacturing techniques. Our goal is to develop lenses and lens assemblies with very high optical & mechanical performance, while achieving the highest manufacturing efficiencies.

Ophir Optics employs optical designers, mechanical engineers, hardware & software engineers and physicists - using the most advanced optical and mechanical design software. We work in close association with our customers and strive to provide unique solutions, perfectly tailored to their specific requirements.

MAINTENANCE



General Precautions

1. Coated surfaces should never be touched. Always hold the optic element by its sides.
2. Always wear powder-free finger cots or latex gloves when handling the optics. Bare hands might leave oils and dirt, which will damage their performance.
3. Do not use any tools or sharp objects when handling the optic element or when removing it from its packaging.
4. Prepare a clean and smooth work surface that is free of oils, grease, dirt, etc.
5. Optic elements will easily scratch when placed on hard surfaces. Once the optic is unpacked, carefully place it on the lens tissue into which it was originally wrapped. Then place the tissue and the lens on a soft cloth or on the foam in the package.

The optic elements were cleaned and packaged in a clean and controlled environment at Ophir and should be ready to install in the laser machine. If an unpacked new optic element does not appear to be clean or seems to have a defect, please contact your local Ophir agent.

The following cleaning methods are for all optic elements. The Black Magic™, Clear Magic™, Duralens™, should be treated with the same care and by the same methods as the standard AR coated CO₂ Optics.

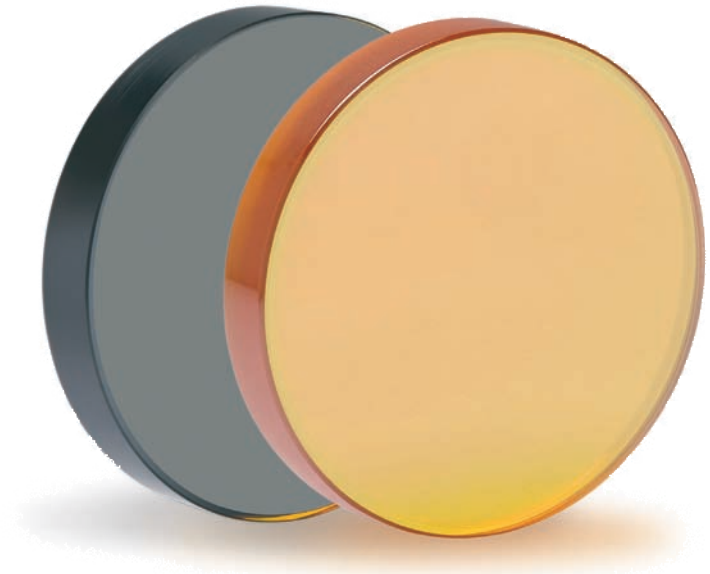

Method A:

Condition of lens: Dust or small loose particles on the surface

Cleaning method:

1. Use a small air bulb to gently blow off dust and debris. Do not use compressed air from a compressor as it is not a "clean" source of air and can contaminate the surface.
2. Gently place the provided optical-grade rice paper on the optic element. Slightly wet the paper with drops of Propa nol/Ethanol (CP grade), using a pipette, and gently pull the paper toward the dry side away from the element, until there is no contact between them.

If this method is not successful, proceed to Method B

MAINTENANCE

Cleaning and Handling

CO₂ Optics Cleaning Instructions

Method B:

Condition of lens: Fingerprints, oil, other visual contaminants

Cleaning method:

1. Use a new clean cotton ball or cotton swab.
2. Dampen cotton with Propanol/Ethanol (CP grade). The cotton must not be dry.
3. Slowly and gently wipe the element in a regular pattern. Do Not scrub the surface (scrubbing might damage the coating or the element itself). Gently wipe element in "S" motion.
4. If the surface is left with wipe marks, wipe it at a slower rate. When finished no streaks should be visible.

Method B (II):

Condition of lens: Moderate contamination (spittle, oils)

Cleaning method:

1. Use a new clean cotton ball or cotton swab.
2. Dampen cotton with acetic acid (or vinegar) with 6% acidity. The cotton must not be dry.
3. Slowly and gently wipe the element in a regular pattern. Do Not scrub the surface (scrubbing might damage the coating or the element itself). Gently wipe element in "S" motion.
4. If the surface is left with wipe marks, wipe it at a slower rate. When finished no streaks should be visible.
5. Slightly wet the provided optical-grade rice paper with drops of Propanol/Ethanol (CP grade), using a pipette and gently pull the paper toward the dry side away from the element, until there is no contact between them, until the residue of acetic acid has been removed.

Method C:

Aggressive Cleaning

Attention: This method is to be used only after trying methods A and B.

In the event that you have completed steps A and B and the optic element is still contaminated please contact your local Ophir Dealer for further instructions.

Condition of lens: Deteriorated performance and severe signs of contamination.

The aggressive cleaning will usually be needed due to heavy usage of the lens. However, certain types of contamination can not be removed and require replacing the optic element.

Cleaning method:

This method might erode the surface of the optics. If a change of surface color is noticeable stop polishing immediately.

1. Use a new clean cotton ball or cotton swab.
2. Dampen cotton with polishing compound (about 5 drops).
3. Gently and briefly wipe optics in "S" motion. Avoid pressing down the cotton or scrubbing the surface.
4. Wet a new cotton ball or swab with Propanol/Ethanol. Gently but thoroughly swab the surface (do not allow it to dry).
5. Examine the surface under light in front of black background. Remove remaining residue by repeating step 4 until surface is clean.

EZ Cleaning Kit is designed to prolong the life of CO2 laser optics used in harsh industrial environments, and developed specifically for High Power CO2 Lasers. Cleaning can help prevent damage to the coatings and substrate to prolong the lens' life. Providing complete, step by step cleaning instructions, the EZ Cleaning Kit for High Power CO2 Laser Optics includes premeasured dispensers for: Alcohol, vinegar and polishing formula for hard to remove spatters and contaminations, as well as lens paper, cotton swabs and finger cots for safe handling.

This Cleaning Kit Includes:

- Air bulb
- Polishing compound (Alumina Oxid Polish)
- Dispensers for Propanol and cleaning fluid
- Finger cots
- Cotton balls
- Lens tissue (optical grade rice paper)



MAINTENANCE

EZ Clean™ and EZ Clean™ Plus

EZ Clean™ and EZ Clean™ Plus wipes

EZ Clean™, an innovative disposable wipe for the routine cleaning of optical laser lenses.

Composed of special non-scratch fabric, the wipe deposits a pre-measured amount of quick-drying cleaning fluid that leaves no residue.

The EZ-Clean package comes with 24 ready-to-use wipes, in which one wipe cleans one lens in a matter of seconds.

Single wipe replaces five-step procedure using ethanol, cotton swabs and lens paper, a few seconds; cleaning translates into significantly less down-time for our customers' machinery.

EZ Clean Plus™ - an innovative wipe used for deeper cleaning of optical laser lenses in conjunction with basic EZ Clean™ Wipes, which are used for more routine cleaning.

Composed of special non-scratch fabric, EZ Clean Wipes deposit a pre-measured amount of ethanol, which is ideal for routine cleaning of laser lenses.

When deeper cleaning is required, EZ Clean Plus wipes are used to counteract the quick-drying effect of the ethanol with a vinegar-based solution that separates dust and other contaminants from the lens surface more effectively.

A final once-over with the basic wipe removes any residue and the lens is ready for use in a matter of seconds.

EZ Clean replaces a five-step process – using ethanol by the bottle, cotton swabs and lens paper – for less laser down-time and longer lens life.



Routine Lens Cleaning Instructions Using EZ Clean™ wipes



Step 1:
Separate one EZ Clean™ wipe



Step 2:
Take out the folded EZ Clean™ wipe



Step 3:
Using an "S" motion, wipe from top to bottom



Step 4:
Turn the lens upside down



Step 5:
Turn the EZ Clean™ wipe to the other side



Step 6:
Using an "S" motion, wipe from top to bottom



Step 7:
Properly dispose the wipe and package



warning: cleaning liquid is flammable;
keep package away from hot surfaces

Second Phase Cleaning With EZ Clean™ Plus wipes



Step 8:

Take out the folded EZ Clean™ Plus wipe



Step 9:

Using an "S" motion, wipe from top to bottom



Step 10:

Turn the lens upside down



Step 11:

Turn the EZ Clean™ Plus wipe to the other side



Step 12:

Using an "S" motion, wipe from top to bottom



Step 13:

Repeat steps 1-7



Step 14:

Properly dispose the wipe and package



warning: cleaning liquid is flammable;
keep package away from hot surfaces

MAINTENANCE

EZ Test™

Lens with stress

Ophir EZ Test™

A CO₂ laser lens is a critical component to your cutting process.

Ophir Optics manufactures a high quality CO₂ optic to assist you in getting the best cut out of your laser. But even the best of products eventually wear out. In the case of a laser lens, if you do not pay attention to the condition of the lens, it can end in costly repairs and downtime.

You know that a lens can fail due to thermal stress or contamination, but how can you tell when a lens is at the end of its life or just needs a cleaning?

Ophir offers an ingenious and simple solution. The Ophir EZ-Test™ is a tool designed to determine the condition of your CO₂ lens.



Polarizers set for lens stress inspection



Lens with stress



Lens without stress

MAINTENANCE

Cleaning and Handling

Stress Check Instructions



Step 1:
Remove the protective layer of the polarizer from both sides



Step 2:
Repeat step 1 for the second polarizer



Step 3:
Place the polarizer in the cleaning holder's dedicated slot



Step 4:
Repeat step 3 for the second polarizer



Step 5:
Place the lens in one of the cleaning holders



Step 6:
Place the second holder on top of the other side of the lens



Step 7:
Twist the top cleaning holder 90° left to view & inspect the lens for stress

GERMANY

Ophir Optronics GmbH – OPG
Bismarckstraße 18,
31582 Nienburg, Germany
Tel. 49-5021-60769-0
Fax. 49-5021-60769-18
e-mail: info@ophiropt.de
www.ophiropt.de

JAPAN

Ophir Japan Ltd. - OJ
4-384 Sakuragi, Omiya, Saitama-city,
Saitama 330-0854
Japan
Tel. 81-48-650-9966
Fax. 81-48-646-4155
e-mail: info@ophirjapan.co.jp
www.ophiropt.com/jp

U.S.A.

Ophir Optics LLC. - OPI
1616 Osgood Street
North Andover, MA 01845
USA
Tel. 1-855-TOP-LENS
(1-855-867-5367)
Fax. 978-657-6056
e-mail: co2@ophiroptics.com
www.co2optics.com

ROMANIA

Ophir Optics SRL
Str. Racari nr. 5,
corp 51B, et. 1, sector 3
Bucuresti,
Romania 031827
Tel: + 40-21-344 4000
Fax: + 40-21-344 4052
e-mail: sales.opr@ophiropt.com
www.ophiroptics.com

INTERNATIONAL HEADQUARTERS

Ophir Optronics Ltd. - OOL
Science - Based Industrial Park
Har Hotzvim, P.O Box 45021
Jerusalem, 9145001
Israel
Tel. 972-2-548-4444
Fax. 972-2-582-2338
e-mail: co2@ophiropt.com
www.co2optics.com

